

### 1. PART NO. EXPRESSION :

C 0 B Q - 1 N 0 S - □ □  
 (a) (b) (c) (d) (e)

- (a) Series code
- (b) Category Code
- (c) Inductance code : 1N0 = 1.0nH
- (d) Inductance Tolerance : B=±0.1nH ,C=±0.2nH ,S=±0.3nH ,H=±3% ,J=±5%
- (e) 10: Standard  
11 ~ 99 : Internal control number

### 2. CONFIGURATION & DIMENSIONS :

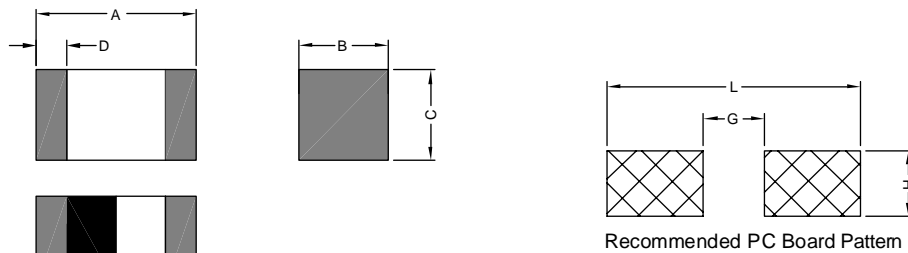

Unit:m/m

A	B	C	D	L	G	H
0.60±0.03	0.30±0.03	0.30±0.03	0.10±0.05	0.80 Ref.	0.20~0.30	0.25~0.40

### 3. SCHEMATIC :

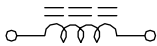

### 4. MATERIALS :

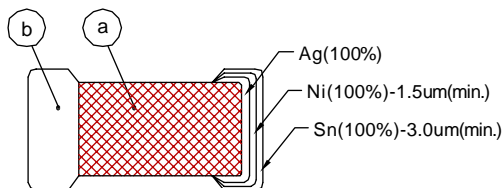

- (a) Body : ceramic ( Pb Free )
- (b) Termination : ( Pb Free )

### 5. GENERAL SPECIFICATION :

- a) Operating temp. : -40° C to +105° C ( including self-temperature. rise )
- b) Storage condition (component in its packaging)
  - i) Temperature : -10 to 40° C
  - ii) Humidity : 60%



**RoHS Compliant**

NOTE : Specifications subject to change without notice. Please check our website for latest information.

28.01.2015



**SUPERWORLD ELECTRONICS (S) PTE LTD**

### 6. ELECTRICAL CHARACTERISTICS :

Part Number	Inductance (nH)	Tolerance	Test Frequency ( MHz )	Q Min	Q(Typ.) Frequency(Hz)					Rated Current (mA) Max	DCR ( Ω ) Max.	SRF ( MHz ) Min.
					500M	800M	1.8G	2.0G	2.4G			
C0BQ-0N6□-10	0.6	B,C,S	500	14	>35	>47	>75	>80	>88	900	0.06	10000
C0BQ-0N7□-10	0.7	B,C,S	500	14	>35	>47	>75	>80	>88	900	0.06	10000
C0BQ-0N8□-10	0.8	B,C,S	500	14	>35	>47	>75	>80	>88	900	0.06	10000
C0BQ-0N9□-10	0.9	B,C,S	500	14	>35	>47	>75	>80	>88	900	0.06	10000
C0BQ-1N0□-10	1.0	B,C,S	500	14	>35	>47	>75	>80	>88	850	0.07	10000
C0BQ-1N1□-10	1.1	B,C,S	500	14	>35	>47	>75	>80	>88	850	0.07	10000
C0BQ-1N2□-10	1.2	B,C,S	500	14	35	47	75	80	88	800	0.08	10000
C0BQ-1N3□-10	1.3	B,C,S	500	14	32	43	70	74	82	760	0.09	10000
C0BQ-1N4□-10	1.4	B,C,S	500	14	29	39	63	67	75	640	0.12	10000
C0BQ-1N5□-10	1.5	B,C,S	500	14	27	36	59	62	69	600	0.15	10000
C0BQ-1N6□-10	1.6	B,C,S	500	14	25	33	54	57	63	510	0.19	10000
C0BQ-1N7□-10	1.7	B,C,S	500	14	25	32	52	54	61	680	0.11	10000
C0BQ-1N8□-10	1.8	B,C,S	500	14	25	32	51	53	59	640	0.12	10000
C0BQ-1N9□-10	1.9	B,C,S	500	14	24	31	50	53	58	620	0.13	10000
C0BQ-2N0□-10	2.0	B,C,S	500	14	24	31	50	53	58	600	0.15	10000
C0BQ-2N1□-10	2.1	B,C,S	500	14	24	31	50	53	58	550	0.16	10000
C0BQ-2N2□-10	2.2	B,C,S	500	14	24	31	50	53	58	500	0.20	10000
C0BQ-2N3□-10	2.3	B,C,S	500	14	24	31	49	52	58	460	0.24	10000
C0BQ-2N4□-10	2.4	B,C,S	500	14	22	28	45	48	53	430	0.26	10000
C0BQ-2N5□-10	2.5	B,C,S	500	14	22	29	46	49	54	415	0.28	10000
C0BQ-2N6□-10	2.6	B,C,S	500	14	21	27	44	46	51	405	0.30	10000
C0BQ-2N7□-10	2.7	B,C,S	500	14	20	26	41	43	48	400	0.32	10000
C0BQ-2N8□-10	2.8	B,C,S	500	14	20	26	41	43	47	500	0.20	9500
C0BQ-2N9□-10	2.9	B,C,S	500	14	20	26	41	43	47	480	0.22	9300
C0BQ-3N0□-10	3.0	B,C,S	500	14	20	26	41	43	47	460	0.24	9100
C0BQ-3N1□-10	3.1	B,C,S	500	14	20	26	41	43	47	450	0.25	8900
C0BQ-3N2□-10	3.2	B,C,S	500	14	20	26	40	43	47	415	0.28	8700
C0BQ-3N3□-10	3.3	B,C,S	500	14	20	26	40	43	47	415	0.28	8600
C0BQ-3N4□-10	3.4	B,C,S	500	14	20	25	40	43	47	410	0.29	8400
C0BQ-3N5□-10	3.5	B,C,S	500	14	20	25	40	42	46	405	0.30	8200
C0BQ-3N6□-10	3.6	B,C,S	500	14	19	25	40	42	46	400	0.32	8100
C0BQ-3N7□-10	3.7	B,C,S	500	14	19	25	40	42	46	370	0.36	8000
C0BQ-3N8□-10	3.8	B,C,S	500	14	19	25	39	41	45	355	0.40	7800
C0BQ-3N9□-10	3.9	B,C,S	500	14	19	25	39	41	45	350	0.41	7700



**RoHS Compliant**

NOTE : Specifications subject to change without notice. Please check our website for latest information.

28.01.2015



**SUPERWORLD ELECTRONICS (S) PTE LTD**

Part Number	Inductance (nH)	Tolerance	Test Frequency ( MHz )	Q Min	Q(Typ.) Frequency(Hz)					Rated Current (mA) Max	DCR ( Ω ) Max.	SRF ( MHz ) Min.
					500M	800M	1.8G	2.0G	2.4G			
C0BQ-4N0□-10	4.0	B,C,S	500	14	18	25	39	41	45	335	0.44	7600
C0BQ-4N1□-10	4.1	B,C,S	500	14	19	25	39	41	45	320	0.48	7500
C0BQ-4N2□-10	4.2	B,C,S	500	14	18	24	37	39	43	320	0.48	7300
C0BQ-4N3□-10	4.3	C,S	500	14	18	24	37	39	43	320	0.48	6500
C0BQ-4N6□-10	4.6	C,S	500	14	18	24	37	39	42	360	0.39	6500
C0BQ-4N7□-10	4.7	C,S	500	14	19	24	37	39	42	350	0.42	6400
C0BQ-5N0□-10	5.0	C,S	500	14	19	24	37	39	42	335	0.44	6200
C0BQ-5N1□-10	5.1	C,S	500	14	19	24	37	39	42	330	0.45	6100
C0BQ-5N4□-10	5.4	C,S	500	14	18	24	36	38	42	315	0.49	5900
C0BQ-5N6□-10	5.6	C,S	500	14	18	24	36	37	41	325	0.47	5500
C0BQ-5N9□-10	5.9	C,S	500	14	18	23	35	36	39	325	0.47	5500
C0BQ-6N2□-10	6.2	C,S	500	14	18	23	35	36	39	305	0.52	5100
C0BQ-6N5□-10	6.5	C,S	500	14	18	23	35	36	39	305	0.52	5100
C0BQ-6N8□-10	6.8	H,J	500	14	18	23	35	36	39	305	0.55	4800
C0BQ-7N1□-10	7.1	H,J	500	14	18	23	35	36	39	305	0.55	4800
C0BQ-7N5□-10	7.5	H,J	500	14	18	23	34	35	38	305	0.55	4600
C0BQ-7N8□-10	7.8	H,J	500	14	17	22	33	34	36	310	0.51	4600
C0BQ-8N2□-10	8.2	H,J	500	14	17	22	33	34	36	290	0.57	4300
C0BQ-8N5□-10	8.5	H,J	500	14	17	22	33	34	36	290	0.57	4300
C0BQ-9N1□-10	9.1	H,J	500	14	17	22	33	34	36	270	0.65	4000
C0BQ-9N4□-10	9.4	H,J	500	14	17	22	33	34	36	250	0.73	4000
C0BQ-10N□-10	10.0	H,J	500	14	17	22	33	34	36	230	0.85	3800
C0BQ-12N□-10	12.0	H,J	500	14	17	22	31	32	33	230	0.85	3300
C0BQ-15N□-10	15.0	H,J	500	14	17	21	28	29	29	220	0.89	2600
C0BQ-18N□-10	18.0	H,J	500	14	16	21	26	26	25	205	1.05	2300
C0BQ-22N□-10	22.0	H,J	500	14	16	21	26	26	24	190	1.29	1900

□ : Inductance Tolerance : B=±0.1nH ,C=±0.2nH ,S=±0.3nH , H=±3% ,J=±5%



**RoHS Compliant**

NOTE : Specifications subject to change without notice. Please check our website for latest information.

28.01.2015



**SUPERWORLD ELECTRONICS (S) PTE LTD**

### 7. CHARACTERISTICS CURVES :

**Impedance v.s. Frequency Characteristics**

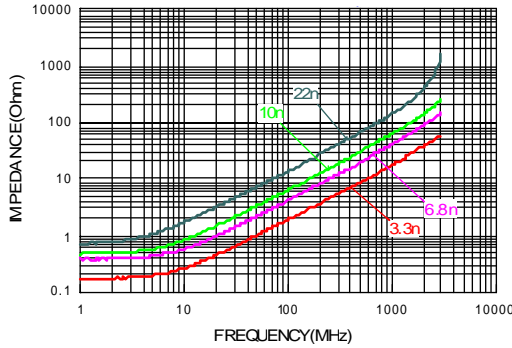

**Inductance v.s. Frequency Characteristics**

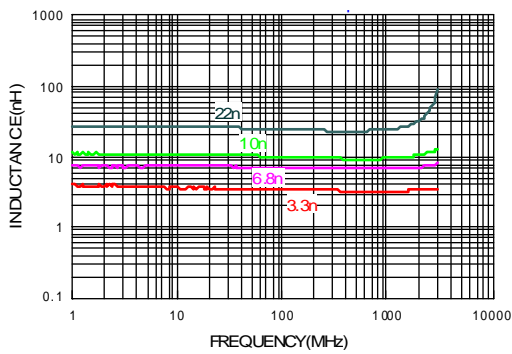

**Q v.s. Frequency Characteristics**

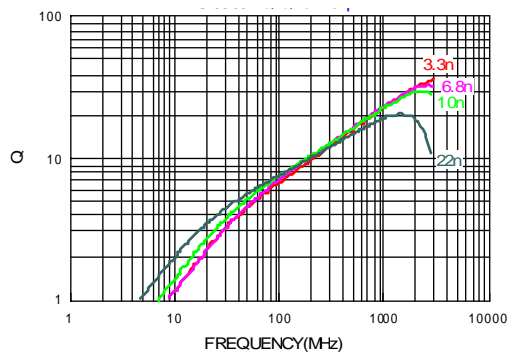

**RoHS Compliant**

NOTE : Specifications subject to change without notice. Please check our website for latest information.

28.01.2015



**SUPERWORLD ELECTRONICS (S) PTE LTD**

## 8. SOLDERING AND MOUNTING :

### 8-1. Recommended PC Board Pattern

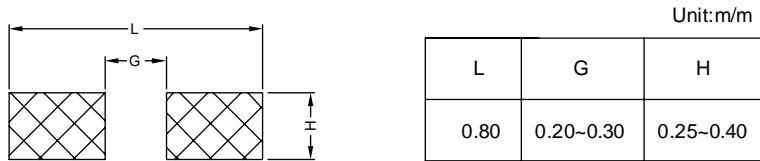

PC board should be designed so that products are not sufficient under mechanical stress as warping the board.

Products shall be positioned in the sideways direction against the mechanical stress to prevent failure.

### 8-2. Soldering

Mildly activated rosin fluxes are preferred. The terminations are suitable for re-flow soldering systems. If hand soldering cannot be avoided, the preferred technique is the utilization of hot air soldering tools.

Note.

If wave soldering is used ,there will be some risk.

Re-flow soldering temperatures below 240 degrees, there will be non-wetting risk

#### 8-2.1 Lead Free Solder Re-flow :

Recommended temperature profiles for re-flow soldering in Figure 1.

#### 8-2.2 Soldering Iron (Figure 2) :

Products attachment with soldering iron is discouraged due to the inherent process Control limitations. In the event that a soldering iron must be employed the following precautions are reCommended.

Note :

- a) Preheat circuit and products to 150° C.
- b) 350° C tip temperature (max)
- c) Never Contact the ceramic with the iron tip
- d) 1.0mm tip diameter (max)
- e) Use a 20 watt soldering iron with tip diameter of 1.0mm
- f) Limit soldering time to 4 ~ 5 secs.

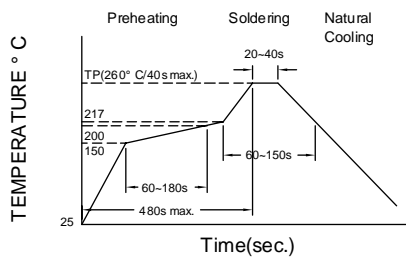

Figure 1. Re-flow Soldering : 3 times max

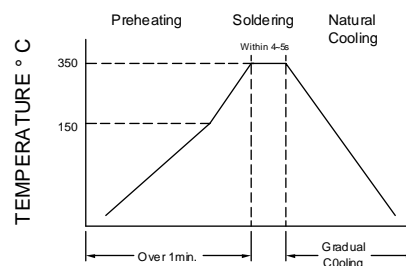

Figure 2. Hand Soldering : 1 times max



**RoHS Compliant**

NOTE : Specifications subject to change without notice. Please check our website for latest information.



### 8-3. Solder Volume

Accordingly increasing the solder volume, the mechanical stress to product is also increased. Exceeding solder volume may cause the failure of mechanical or electrical performance. Solder shall be used not to be exceed as shown in Fig. 3.

Minimum fillet height = soldering thickness + 25% product height

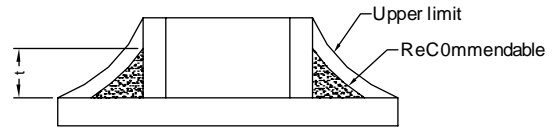

Figure 3



**RoHS Compliant**

NOTE : Specifications subject to change without notice. Please check our website for latest information.

28.01.2015



**SUPERWORLD ELECTRONICS (S) PTE LTD**

PG. 6

### 9. PACKAGING INFORMATION :

#### 9-1. Reel Dimension

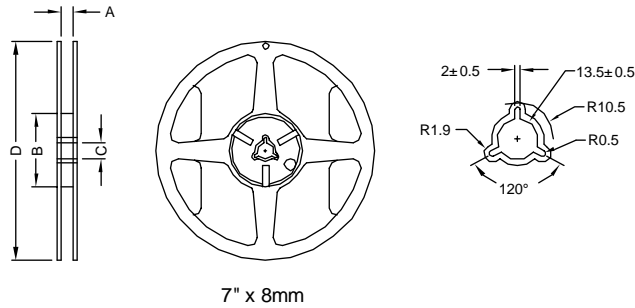

Type	A(mm)	B(mm)	C(mm)	D(mm)
7" x 8mm	9.0±0.5	60±2	13.52±0.5	178.0±2.0

#### 9-2 Tape Dimension / 8mm

Material : Paper

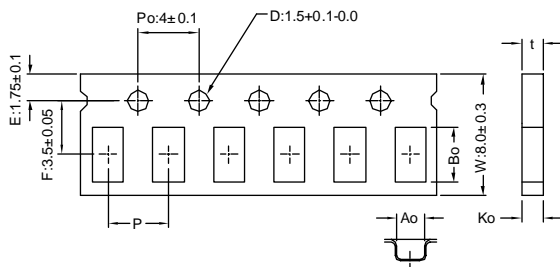

Size	Bo(mm)	Ao(mm)	Ko(mm)	P(mm)	t(mm)
C0	0.70±0.06	0.40±0.06	0.45 max	2.0±0.05	0.45 max

#### 9-3. Packaging Quantity

Chip Size	C0
Chip / Reel	15000
Inner Box	75000
Middle Box	375000
Carton	750000



**RoHS Compliant**

NOTE : Specifications subject to change without notice. Please check our website for latest information.

28.01.2015



**SUPERWORLD ELECTRONICS (S) PTE LTD**

### 9-4. Tearing Off Force

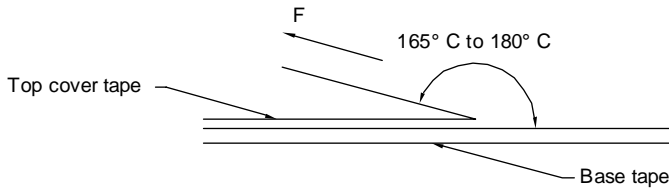

The force for tearing off cover tape is 15 to 60 grams in the arrow direction under the following conditions.

Room Temp. (° C)	Room Humidity (%)	Room atm (hPa)	Tearing Speed (mm/min)
5~35	45~85	860~1060	300

### Application Notice

#### 1. Storage Conditions :

To maintain the solderability of terminal electrodes :

- a) Recommended products should be used within 12 months from the time of delivery.
- b) The packaging material should be kept where no chlorine or sulfur exists in the air.

#### 2. Transportation :

- a) Products should be handled with care to avoid damage or contamination from perspiration and skin oils.
- b) The use of tweezers or vacuum pick up is strongly recommended for individual components.
- c) Bulk handling should ensure that abrasion and mechanical shock are minimized.



**RoHS Compliant**

NOTE : Specifications subject to change without notice. Please check our website for latest information.

28.01.2015



**SUPERWORLD ELECTRONICS (S) PTE LTD**