

### 1. PART NO. EXPRESSION :

C 0 - 1 N 0 S - □□  
 (a) (b) (c) (d)

(a) Series code

(b) Inductance code : 1N0 = 1.0nH

(c) Inductance Tolerance : S=± 0.3nH , J=± 5% , K=± 10%

(d) 10: Standard

11 ~ 99 : Internal control number

### 2. CONFIGURATION & DIMENSIONS :

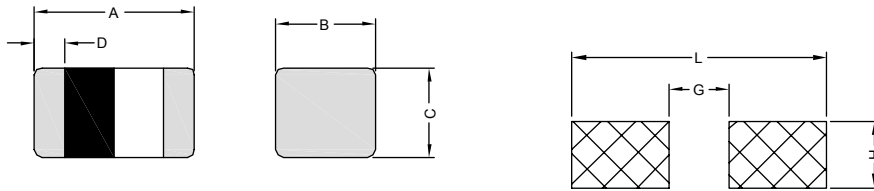

Recommended PC Board Pattern

Unit:m/m

| A          | B          | C          | D          | G         | H         | L    |
|------------|------------|------------|------------|-----------|-----------|------|
| 0.60± 0.03 | 0.30± 0.03 | 0.30± 0.03 | 0.15± 0.05 | 0.20~0.30 | 0.25~0.40 | 0.80 |

### 3. SCHEMATIC :

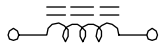

### 4. MATERIALS :

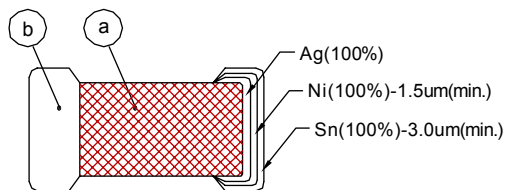

(a) Body : ceramic ( Pb Free )

(b) Termination : ( Pb Free )

### 5. GENERAL SPECIFICATION :

- a) Operating temp. : -40° C to +105° C ( including self-temperature. rise )
- b) Storage condition (component in its packaging)
  - i) Temperature : -10 to 40° C
  - ii) Humidity : 60%



**RoHS Compliant**

NOTE : Specifications subject to change without notice. Please check our website for latest information.

26.01.2015

### 6. ELECTRICAL CHARACTERISTICS :

| Part Number | Inductance<br>(nH) | Test Frequency<br>( MHz ) | Q<br>Min | Q(Typ.) Frequency(MHz) |     |     |     |      | Rated Current<br>(mA) Max | DC Resistance<br>( Ω ) |      | SRF<br>( MHz ) |       |
|-------------|--------------------|---------------------------|----------|------------------------|-----|-----|-----|------|---------------------------|------------------------|------|----------------|-------|
|             |                    |                           |          | 100                    | 300 | 500 | 800 | 1000 |                           | Typ.                   | Max. | Typ.           | Min   |
| C0-1N0S-10  | 1.0                | 100                       | 4        | 6                      | 12  | 17  | 22  | 27   | 470                       | 0.088                  | 0.11 | >13000         | 10000 |
| C0-1N2S-10  | 1.2                | 100                       | 4        | 6                      | 12  | 16  | 21  | 25   | 450                       | 0.089                  | 0.12 | >13000         | 10000 |
| C0-1N5S-10  | 1.5                | 100                       | 4        | 6                      | 12  | 15  | 20  | 23   | 430                       | 0.11                   | 0.13 | >13000         | 10000 |
| C0-1N8S-10  | 1.8                | 100                       | 4        | 6                      | 12  | 15  | 20  | 23   | 390                       | 0.12                   | 0.16 | >13000         | 10000 |
| C0-2N0S-10  | 2.0                | 100                       | 4        | 6                      | 12  | 15  | 20  | 22   | 380                       | 0.13                   | 0.17 | >13000         | 10000 |
| C0-2N2S-10  | 2.2                | 100                       | 4        | 6                      | 12  | 15  | 20  | 22   | 360                       | 0.14                   | 0.19 | 12500          | 8800  |
| C0-2N4S-10  | 2.4                | 100                       | 4        | 6                      | 12  | 15  | 20  | 22   | 350                       | 0.15                   | 0.20 | 11700          | 8300  |
| C0-2N7S-10  | 2.7                | 100                       | 5        | 7                      | 12  | 15  | 20  | 22   | 340                       | 0.16                   | 0.21 | 11000          | 7700  |
| C0-3N0S-10  | 3.0                | 100                       | 5        | 7                      | 12  | 15  | 20  | 22   | 330                       | 0.18                   | 0.22 | 11000          | 7200  |
| C0-3N3S-10  | 3.3                | 100                       | 5        | 7                      | 12  | 15  | 20  | 22   | 320                       | 0.19                   | 0.23 | 9600           | 6700  |
| C0-3N6S-10  | 3.6                | 100                       | 5        | 7                      | 12  | 15  | 20  | 22   | 310                       | 0.20                   | 0.25 | 9100           | 6400  |
| C0-3N9S-10  | 3.9                | 100                       | 5        | 7                      | 12  | 15  | 20  | 22   | 300                       | 0.20                   | 0.27 | 8600           | 6000  |
| C0-4N3S-10  | 4.3                | 100                       | 5        | 7                      | 12  | 15  | 19  | 21   | 280                       | 0.22                   | 0.30 | 8100           | 5700  |
| C0-4N7S-10  | 4.7                | 100                       | 5        | 7                      | 12  | 15  | 19  | 21   | 280                       | 0.24                   | 0.30 | 7600           | 5300  |
| C0-5N1S-10  | 5.1                | 100                       | 5        | 7                      | 12  | 15  | 19  | 21   | 270                       | 0.26                   | 0.33 | 7100           | 5000  |
| C0-5N6S-10  | 5.6                | 100                       | 5        | 7                      | 12  | 15  | 19  | 21   | 260                       | 0.27                   | 0.36 | 6600           | 4600  |
| C0-6N2S-10  | 6.2                | 100                       | 5        | 7                      | 11  | 14  | 18  | 20   | 250                       | 0.29                   | 0.38 | 6100           | 4200  |
| C0-6N8J-10  | 6.8                | 100                       | 5        | 7                      | 11  | 14  | 18  | 20   | 250                       | 0.30                   | 0.39 | 5600           | 3900  |
| C0-7N5J-10  | 7.5                | 100                       | 5        | 7                      | 11  | 14  | 18  | 19   | 240                       | 0.34                   | 0.41 | 5300           | 3600  |
| C0-8N2J-10  | 8.2                | 100                       | 5        | 7                      | 11  | 14  | 18  | 19   | 230                       | 0.34                   | 0.45 | 4900           | 3400  |
| C0-9N1J-10  | 9.1                | 100                       | 5        | 7                      | 11  | 14  | 17  | 18   | 220                       | 0.40                   | 0.48 | 4600           | 3200  |
| C0-10NJ-10  | 10                 | 100                       | 5        | 7                      | 11  | 14  | 17  | 18   | 220                       | 0.41                   | 0.51 | 4200           | 2900  |
| C0-12NJ-10  | 12                 | 100                       | 5        | 7                      | 11  | 14  | 17  | 18   | 190                       | 0.45                   | 0.68 | 3800           | 2700  |
| C0-15NJ-10  | 15                 | 100                       | 5        | 7                      | 11  | 13  | 16  | 17   | 180                       | 0.50                   | 0.71 | 3300           | 2300  |
| C0-18NJ-10  | 18                 | 100                       | 5        | 7                      | 11  | 13  | 16  | 17   | 170                       | 0.57                   | 0.81 | 3000           | 2100  |
| C0-22NJ-10  | 22                 | 100                       | 5        | 7                      | 11  | 13  | 15  | 16   | 150                       | 0.71                   | 1.00 | 2600           | 1800  |
| C0-27NJ-10  | 27                 | 100                       | 4        | 6                      | 10  | 12  | 14  | 15   | 120                       | 1.11                   | 1.35 | 2600           | 1800  |
| C0-33NJ-10  | 33                 | 100                       | 4        | 6                      | 10  | 12  | 14  | 14   | 110                       | 1.33                   | 1.47 | 2400           | 1700  |
| C0-39NJ-10  | 39                 | 100                       | 4        | 6                      | 10  | 12  | 13  | 12   | 100                       | 1.51                   | 1.72 | 2100           | 1500  |
| C0-47NJ-10  | 47                 | 100                       | 4        | 6                      | 10  | 11  | 12  | 11   | 100                       | 1.74                   | 1.90 | 1800           | 1300  |
| C0-56NJ-10  | 56                 | 100                       | 4        | 6                      | 10  | 11  | 11  | 10   | 80                        | 1.85                   | 2.27 | 1600           | 1100  |
| C0-68NJ-10  | 68                 | 100                       | 4        | 6                      | 10  | 11  | 11  | 10   | 80                        | 2.30                   | 2.66 | 1500           | 1100  |
| C0-82NJ-10  | 82                 | 100                       | 4        | 6                      | 10  | 11  | 10  | 8    | 70                        | 2.60                   | 3.37 | 1400           | 1000  |
| C0-R10J-10  | 100                | 100                       | 4        | 6                      | 9   | 10  | 9   | 6    | 60                        | 3.00                   | 3.74 | 1200           | 900   |

Inductance Tolerance : S=± 0.3nH , J=± 5% , K=± 10%



**RoHS Compliant**

NOTE : Specifications subject to change without notice. Please check our website for latest information.

26.01.2015



**SUPERWORLD ELECTRONICS (S) PTE LTD**

### 7. CHARACTERISTICS CURVES :

Impedance v.s. Frequency Characteristics

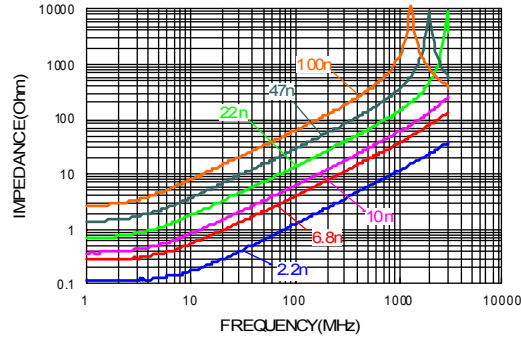

Inductance v.s. Frequency Characteristics

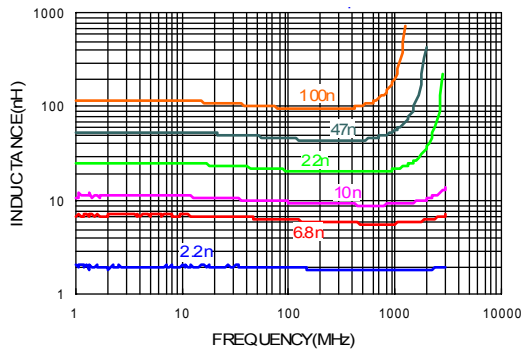

Q v.s. Frequency Characteristics

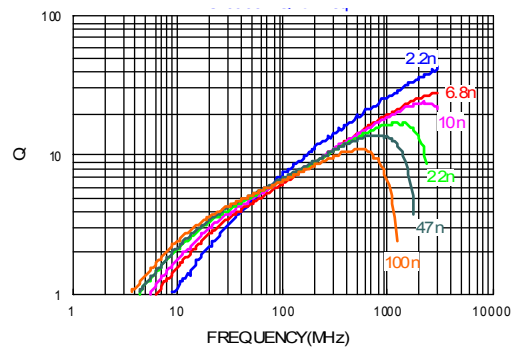

**RoHS Compliant**

NOTE : Specifications subject to change without notice. Please check our website for latest information.

26.01.2015



**SUPERWORLD ELECTRONICS (S) PTE LTD**

### 8. SOLDERING AND MOUNTING :

#### 8-1. Recommended PC Board Pattern

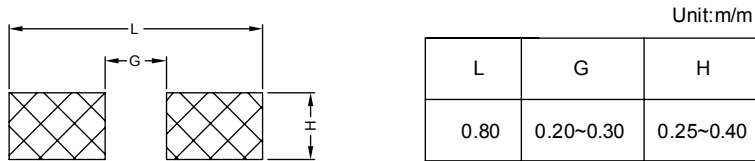

PC board should be designed so that products can prevent damage from mechanical stress when warping the board.

#### 8-2. Soldering

Mildly activated rosin fluxes are preferred. The terminations are suitable for re-flow soldering systems. If hand soldering cannot be avoided, the preferred technique is the utilization of hot air soldering tools.

Note.

If wave soldering is used, there will be some risk.

Re-flow soldering temperatures below 240 degrees, there will be non-wetting risk

##### 8-2.1 Lead Free Solder Re-flow :

Recommended temperature profiles for lead free re-flow soldering in Figure 1. (Referred to J-STD-020C)

##### 8-2.2 Soldering Iron :

Products attachment with a soldering iron is discouraged due to the inherent process control limitations. If a soldering iron must be employed the following precautions are recommended. for Iron Soldering in Figure 2.

Note :

- a) Preheat circuit and products to 150° C.
- b) 350° C tip temperature for Ferrite chip bead (max)
- c) Never contact the ceramic with the iron tip
- d) 1.0mm tip diameter (max)
- e) Use a 20 watt soldering iron with tip diameter of 1.0mm
- f) Limit soldering time to 4-5 secs.

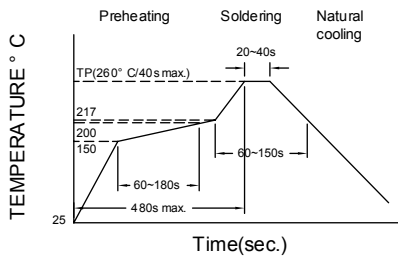

Figure 1. Re-flow Soldering:3 times max

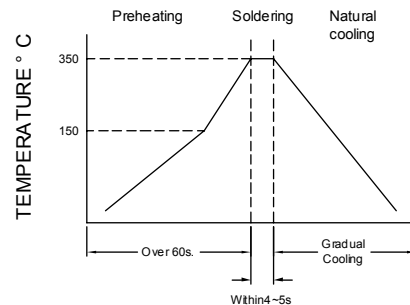

Figure 2. Wave Soldering:1 times max



**RoHS Compliant**

NOTE : Specifications subject to change without notice. Please check our website for latest information.



### 8-3. Solder Volume

Accordingly increasing the solder volume, the mechanical stress to product is also increased. Exceeding solder volume may cause the failure of mechanical or electrical performance. Solder shall be used not to be exceed as shown in Fig. 3.

Minimum fillet height = soldering thickness + 25% product height

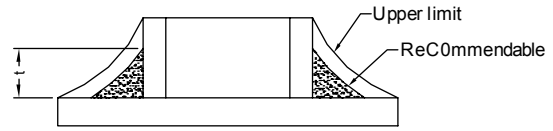

Figure 3



**RoHS Compliant**

NOTE : Specifications subject to change without notice. Please check our website for latest information.

26.01.2015



**SUPERWORLD ELECTRONICS (S) PTE LTD**

PG. 5

### 9. PACKAGING INFORMATION :

#### 9-1. Reel Dimension

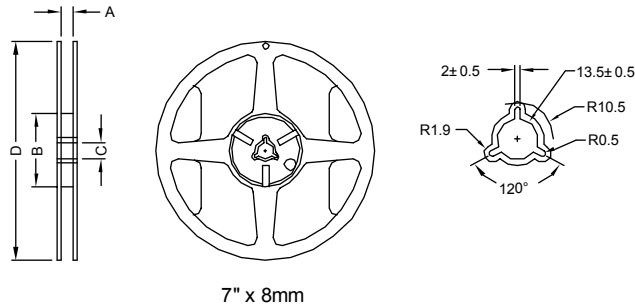

| Type     | A(mm)   | B(mm) | C(mm)    | D(mm)     |
|----------|---------|-------|----------|-----------|
| 7" x 8mm | 9.0±0.5 | 60±2  | 13.5±0.5 | 178.0±2.0 |

#### 9-2 Tape Dimension / 8mm

Material : Paper

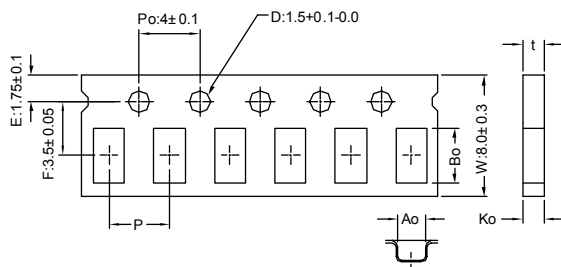

| Size | Bo(mm)    | Ao(mm)    | Ko(mm)   | P(mm)    | t(mm)    |
|------|-----------|-----------|----------|----------|----------|
| C0   | 0.70±0.06 | 0.40±0.06 | 0.45 max | 2.0±0.05 | 0.45 max |

#### 9-3. Packaging Quantity

|             |        |
|-------------|--------|
| Chip Size   | C0     |
| Chip / Reel | 15000  |
| Inner Box   | 75000  |
| Middle Box  | 375000 |
| Carton      | 750000 |



**RoHS Compliant**

NOTE : Specifications subject to change without notice. Please check our website for latest information.

26.01.2015



**SUPERWORLD ELECTRONICS (S) PTE LTD**

### 9-4. Tearing Off Force

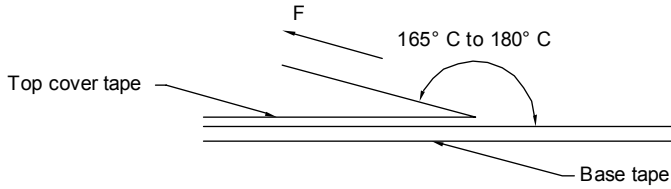

The force for tearing off cover tape is 15 to 60 grams in the arrow direction under the following conditions.

| Room Temp. (° C) | Room Humidity (%) | Room atm (hPa) | Tearing Speed (mm/min) |
|------------------|-------------------|----------------|------------------------|
| 5~35             | 45~85             | 860~1060       | 300                    |

### Application Notice

#### 1. Storage Conditions :

To maintain the solderability of terminal electrodes :

- a) Recommended products should be used within 12 months from the time of delivery.
- b) The packaging material should be kept where no chlorine or sulfur exists in the air.

#### 2. Transportation :

- a) Products should be handled with care to avoid damage or contamination from perspiration and skin oils.
- b) The use of tweezers or vacuum pick up is strongly recommended for individual components.
- c) Bulk handling should ensure that abrasion and mechanical shock are minimized.



**RoHS Compliant**

NOTE : Specifications subject to change without notice. Please check our website for latest information.

26.01.2015



**SUPERWORLD ELECTRONICS (S) PTE LTD**

PG. 7