

## 1. Part No. Expression:

**SPA252010HF□□□M**

(a) (b) (c) (d) (e)

- a) Series Code
- b) Dimension Code
- c) Type Code
- d) Inductance Code
- e) Tolerance Code

## 2. Configuration & Dimensions:

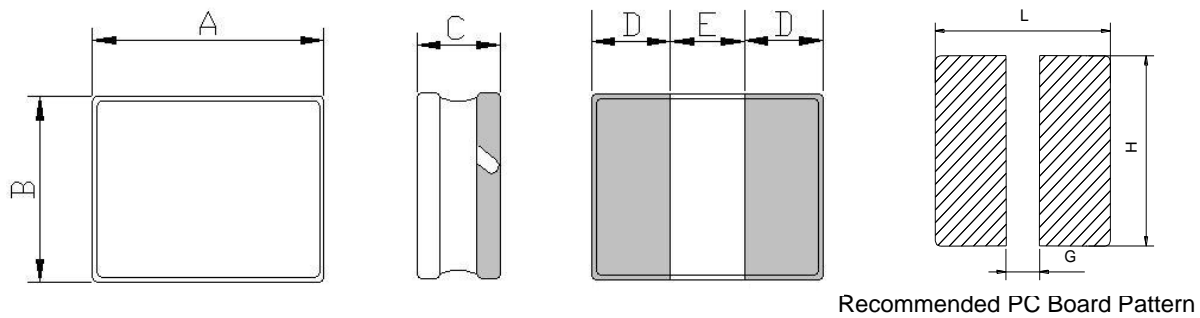

Unit: mm

A	B	C	D	E	L	G	H
2.5 +0.2/-0.1	2.0 +0.2/-0.1	1.0 Max.	0.75 Ref.	1.0 Ref.	2.9 Ref.	1.0 Ref.	2.4 Ref.

## 3. Material List:

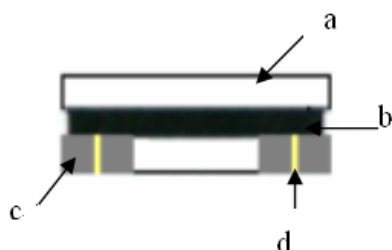

- (a) Core
- (b) Glue
- (c) Termination
- (d) Wire

NOTE: Specifications subject to change without notice. Please check our website for latest information.

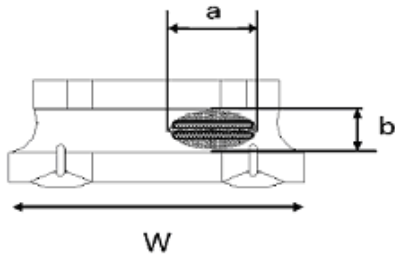

Appearance of exposed wire tolerance limit :

1. Width direction ( dimension a ) : Acceptable when  $a \leq w/2$   
Non-acceptable when  $a > w/2$
2. Length direction ( dimension b ) : Dimension b is not specified.
3. The total acceptable area of exposed wire occurring to each sides is no greater than 50% of coating resin area.

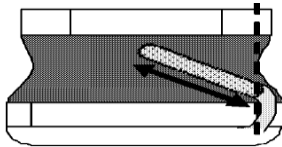

External appearance criterion for exposed wire

Exposed end of the winding wire at the secondary side should be 2mm and below.

## 4. General Specification:

- (a) Operating Temp. : -40°C to +125°C (Inclusive of coil temp rise).
- (b) Storage Temp. : -40°C to +125°C (on board).
- (c) Heat Rated Current (Irms) will cause the coil temperature rise approximately  $\Delta t$  of 40°C.
- (d) Saturation Current (Isat) will cause L0 to drop approximately 30%.
- (e) Storage condition (component in its packaging)
  - i) Temperature: Less than 40°C
  - ii) Humidity : 60% RH

NOTE: Specifications subject to change without notice. Please check our website for latest information.

## 5. Electrical Characteristics:

Part Number	Inductance (uH)	Test Frequency (Hz)	DCR ( $\Omega$ )		I sat (A)		I rms (A)	
			Typ.	Max.	Typ.	Max.	Typ.	Max.
SPA252010HFR16M	0.16	1V/1M	0.015	0.020	8.50	7.50	6.00 (1) 6.50 (2)	5.50 (1) 6.00 (2)
SPA252010HFR24M	0.24	1V/1M	0.022	0.028	7.20	6.70	5.50 (1) 6.00 (2)	5.00 (1) 5.50 (2)
SPA252010HFR33M	0.33	1V/1M	0.023	0.029	6.00	5.50	4.80 (1) 5.00 (2)	4.30 (1) 4.50 (2)
SPA252010HFR47M	0.47	1V/1M	0.029	0.035	5.50	4.90	4.50 (1) 4.70 (2)	3.90 (1) 4.20 (2)
SPA252010HFR56M	0.56	1V/1M	0.035	0.042	4.50	4.00	3.90 (1) 4.10 (2)	3.50 (1) 3.70 (2)
SPA252010HFR68M	0.68	1V/1M	0.036	0.043	4.40	3.80	3.80 (1) 4.00 (2)	3.40 (1) 3.60 (2)
SPA252010HFR82M	0.82	1V/1M	0.043	0.052	3.80	3.20	3.60 (1) 3.80 (2)	3.10 (1) 3.30 (2)
SPA252010HF1R0M	1.0	1V/1M	0.044	0.053	3.60	3.10	3.50 (1) 3.70 (2)	3.00 (1) 3.20 (2)
SPA252010HF1R2M	1.2	1V/1M	0.070	0.084	3.50	3.00	2.60 (1) 2.90 (2)	2.30 (1) 2.50 (2)
SPA252010HF1R5M	1.5	1V/1M	0.072	0.086	3.20	2.70	2.50 (1) 2.80 (2)	2.20 (1) 2.40 (2)
SPA252010HF1R8M	1.8	1V/1M	0.088	0.106	2.70	2.30	2.50 (1) 2.70 (2)	2.20 (1) 2.40 (2)
SPA252010HF2R2M	2.2	1V/1M	0.090	0.108	2.50	2.10	2.40 (1) 2.60 (2)	2.10 (1) 2.30 (2)
SPA252010HF3R3M	3.3	1V/1M	0.190	0.230	2.00	1.70	1.50 (1) 1.70 (2)	1.30 (1) 1.50 (2)
SPA252010HF4R7M	4.7	1V/1M	0.220	0.264	1.70	1.40	1.40 (1) 1.60 (2)	1.20 (1) 1.40 (2)

\*For I rms (A) Max. values with '(1)' or '(2)', refer to notes below for board test conditions.

NOTE: Specifications subject to change without notice. Please check our website for latest information.

Notes:

- 1) At all times, the current supplied to the product should not exceed Irms Max. value
- 2) Irms Max. board test conditions:

Irms (1)

Material: FR4

Board dimensions: 100 X 50 X 1.6t mm

Pattern dimensions: 45 X 30 mm (Double side board)

Pattern thickness: 50 μm

Irms (2)

Material: FR4

Board dimensions: 100 X 50 X 1.6t mm

Pattern dimensions: 45 X 45 mm (Double side board)

Pattern thickness: 70 μm

### 6. Characteristics Curves:

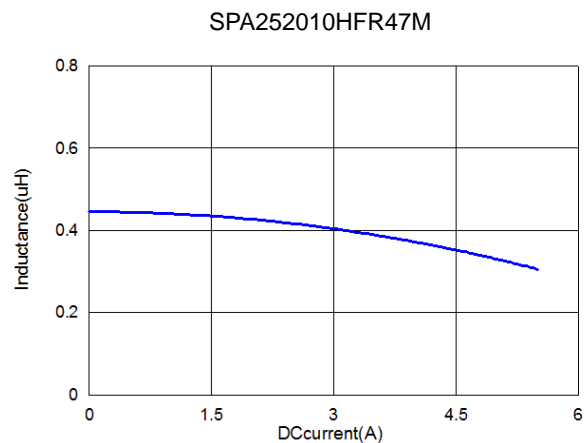
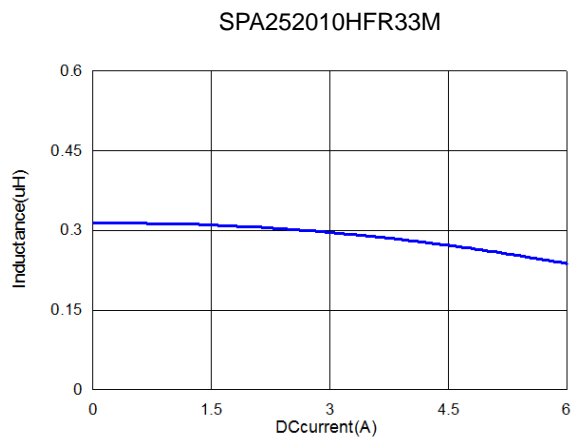
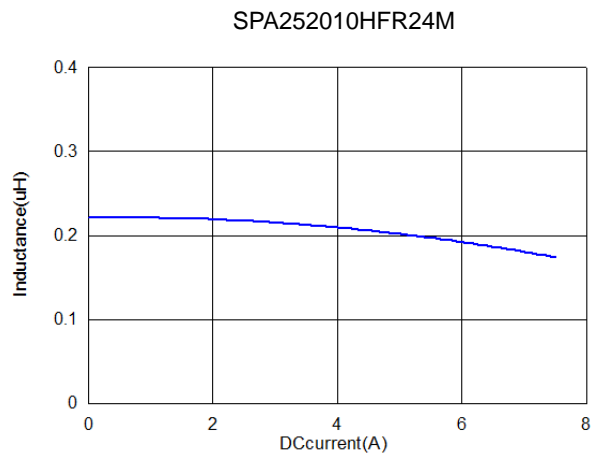
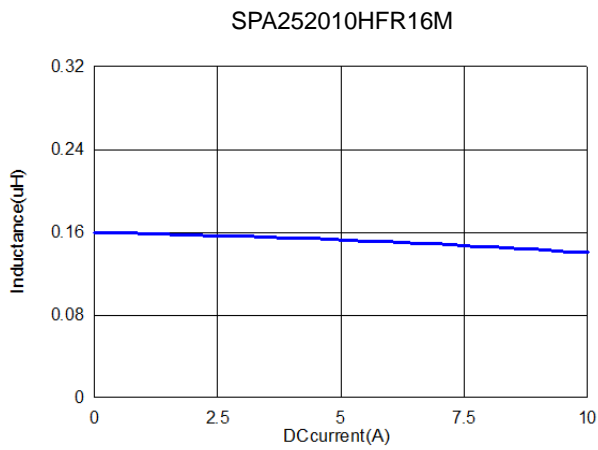

NOTE: Specifications subject to change without notice. Please check our website for latest information.



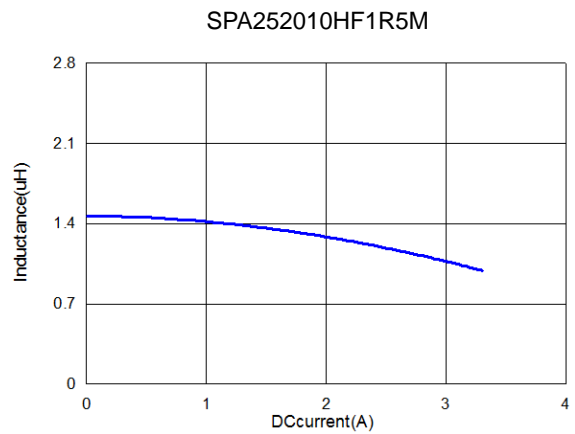
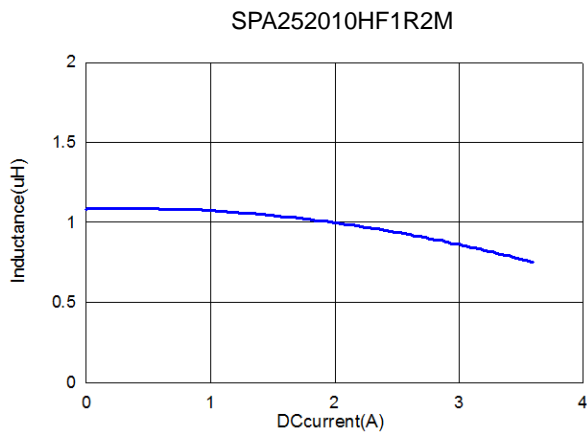
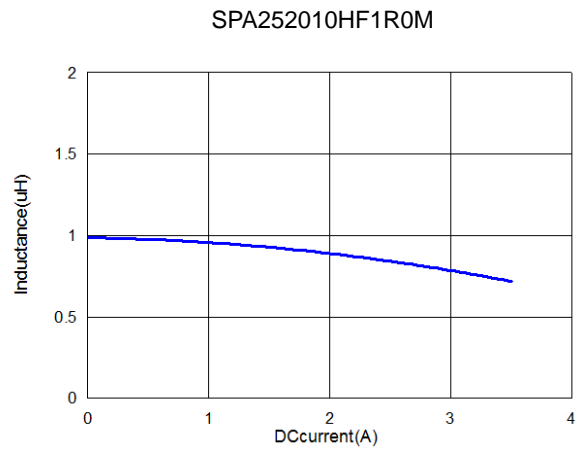
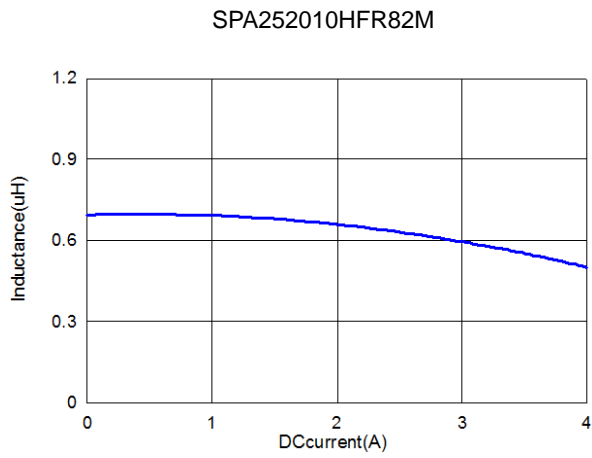
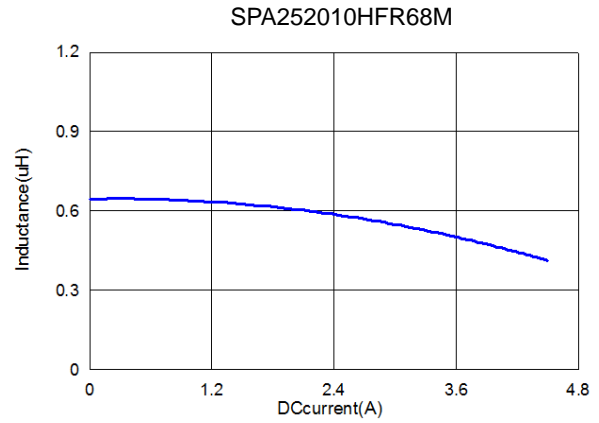
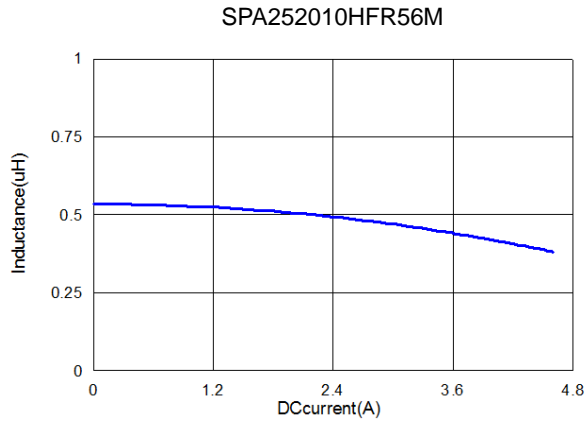

NOTE: Specifications subject to change without notice. Please check our website for latest information.



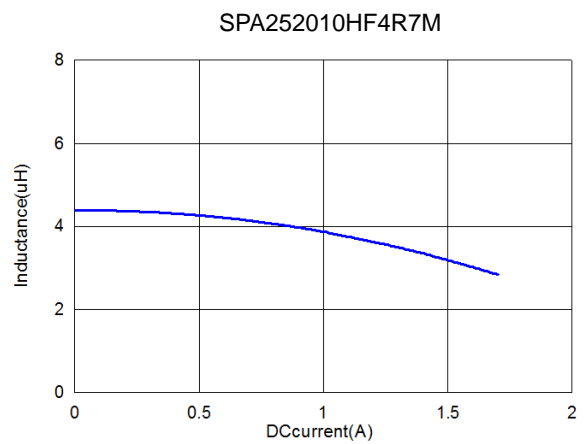
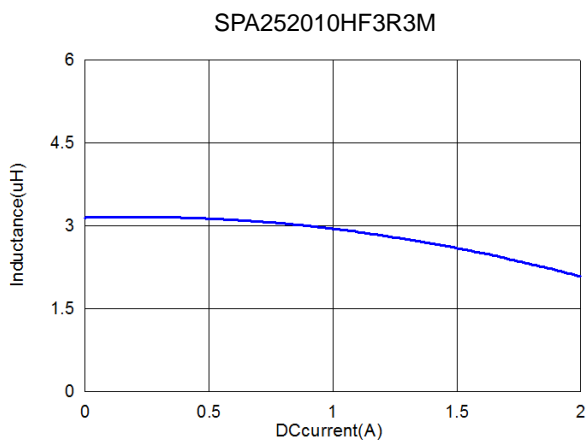
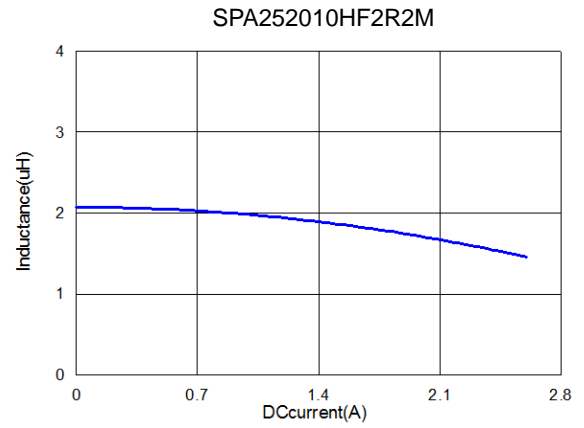
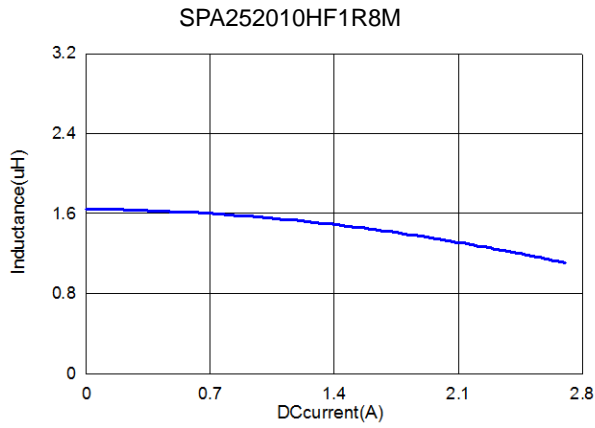

NOTE: Specifications subject to change without notice. Please check our website for latest information.



**7. Soldering:**

Mildly activated rosin fluxes are preferred. The minimum amount of solder can lead to damage from the stresses caused by the difference in coefficients of expansion between solder, chip and substrate. Our terminations are suitable for all re-flow soldering systems. If hand soldering cannot be avoided, the preferred technique is the utilization of hot air.

**7-1 Solder Re-flow:**

Recommended temperature profiles for re-flow soldering in Figure 1.

**7-2 Soldering Iron (Figure 2):**

Products attachment with soldering iron is discouraged due to the inherent process control limitations. In the event that a soldering iron must be employed the following precautions are recommended.

Note :

- a) Preheat circuit and products to 150°C.
- b) 355°C tip temperature (Max.)
- c) Never contact the ceramic with the iron tip
- d) 1.0mm tip diameter (Max.)
- e) Use a 20 watt soldering iron with tip diameter of 1.0mm
- f) Limit soldering time to 4~5 secs.

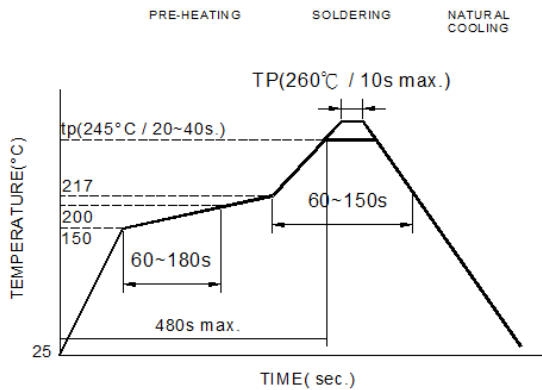

Reflow times: 3 times max.

Fig.1

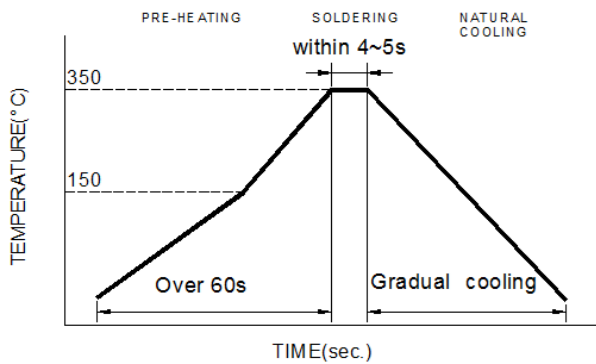

Iron Soldering times: 1 times max.

Fig.2

NOTE: Specifications subject to change without notice. Please check our website for latest information.



8. Packaging Information:

8-1 Reel Dimension

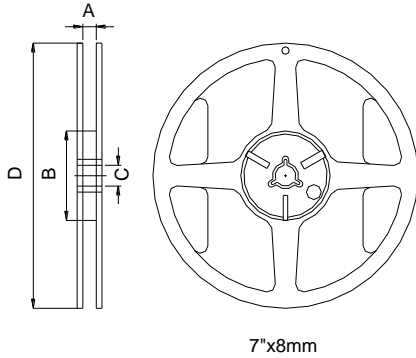

Type	A(mm)	B(mm)	C(mm)	D(mm)
7"x8mm	8.4±1.0	50 Min.	13±0.8	178±2

8-2 Tape Dimension

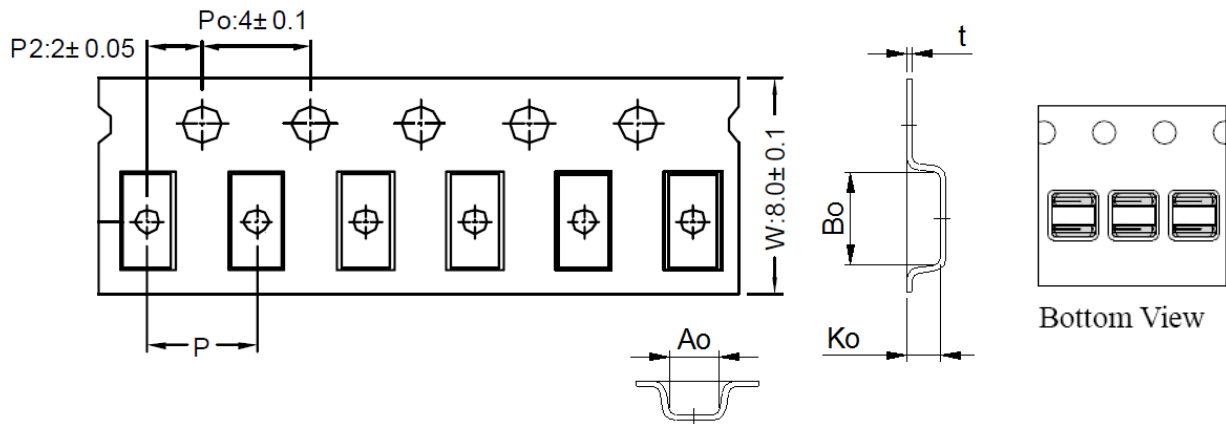

Series	Size	Bo(mm)	Ao(mm)	Ko(mm)	P(mm)	t(mm)
SPA	252010	3.10±0.1	2.45±0.1	1.40±0.1	4.0±0.1	0.23±0.05

8-3 Packaging Quantity

Chip size	SPA252010
Chip / Reel	2000

NOTE: Specifications subject to change without notice. Please check our website for latest information.



**8-4 Tearing Off Force**

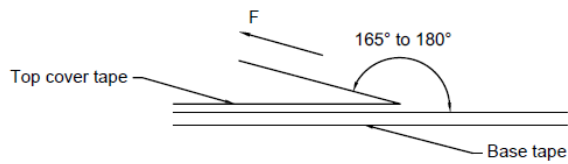

The force for tearing off cover tape is 15 to 80 grams in the arrow direction under the following conditions

Room Temp. (°C)	Room Humidity (%)	Room atm (hPa)	Tearing Speed mm/min
5~35	45~85	860~1060	300

**Application Notice:**

1. Storage Conditions:

To maintain the solderability of terminal electrodes:

- a) Recommended products should be used within 12 months from the time of delivery.
- b) The packaging material should be kept where no chlorine or sulfur exists in the air.

2. Transportation:

- a) Products should be handled with care to avoid damage or contamination from perspiration and skin oils.
- b) Vacuum pick up is strongly recommended for individual components.
- c) Bulk handling should ensure that abrasion and mechanical shock are minimized.

NOTE: Specifications subject to change without notice. Please check our website for latest information.

