

1. Part No. Expression:

W 3 F 9 0 0 - R D - □□

(a) (b)(c) (d) (e)(f) (g)

(a) Series Code

(b) Dimension Code

(c) Material Code

(d) Impedance Code

(e) Packaging Code

(f) Current Rating Code D = 400mA

(g) Internal controlled number

2. Configuration & Dimensions

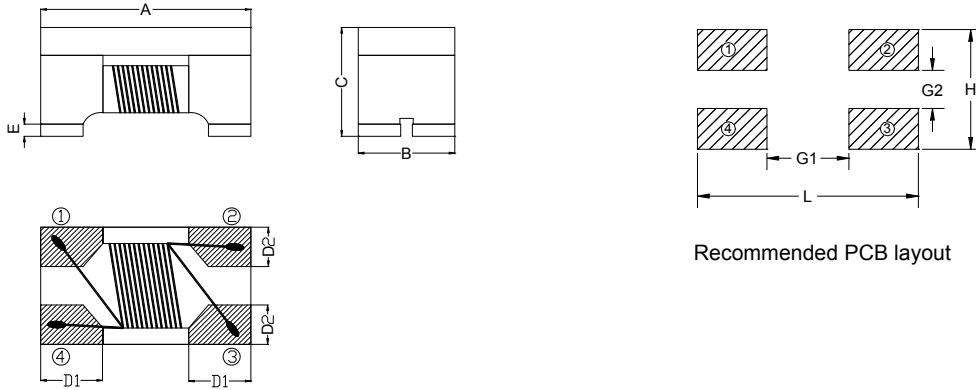

Recommended PCB layout

Unit: mm

A	B	C	D1	D2	E	L	G1	G2	H
2.0±0.2	1.2±0.2	1.2±0.2	0.55±0.1	0.46±0.1	0.15±0.1	2.60	1.10	0.45	1.25

3. Schematic

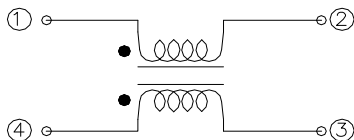

NOTE: Specifications subject to change without notice. Please check our website for latest information.



4. Material List

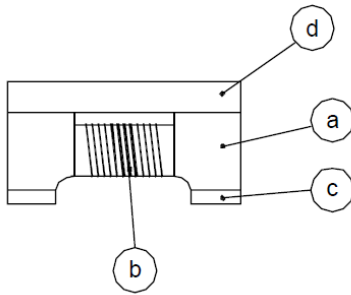

- (a) Core
- (b) Wire
- (c) Terminal
- (d) Upper Plate

5. General Specification

- (a) Operating Temp. : -40°C to +125°C
- (b) Storage Temp. : -40°C to +125°C (on board)
- (c) Humidity Range: 85 ± 2% RH
- (d) Storage Condition (Component in its packaging)
 - i) Temperature: Less than 40°C
 - ii) Humidity : 60% RH

6. Electrical Characteristics

Part Number	Common Mode Impedance (Ω)	Test Frequency (MHz)	DC Resistance (Ω) Max.	Rated Current (mA) Max.	Rated Volt. (Vdc) Max.	Withstand Volt. (Vdc) Max.	IR (Ω) Min.
W3F670-RD-10	67±25%	100	0.25	400	50	125	10M
W3F900-RD-10	90±25%	100	0.30	400	50	125	10M
W3F121-RD-10	120±25%	100	0.30	400	50	125	10M
W3F161-RC-10	160±25%	100	0.35	350	50	125	10M
W3F181-RC-10	180±25%	100	0.35	350	50	125	10M
W3F201-RC-10	200±25%	100	0.40	300	50	125	10M
W3F221-RC-10	220±25%	100	0.40	300	50	125	10M
W3F261-RC-10	260±25%	100	0.40	300	50	125	10M
W3F361-RC-10	360±25%	100	0.50	300	50	125	10M
W3F371-RA-10	370±25%	100	0.50	100	50	125	10M

NOTE: Specifications subject to change without notice. Please check our website for latest information.

7. Characteristics Curves

7-1 Impedance vs Frequency

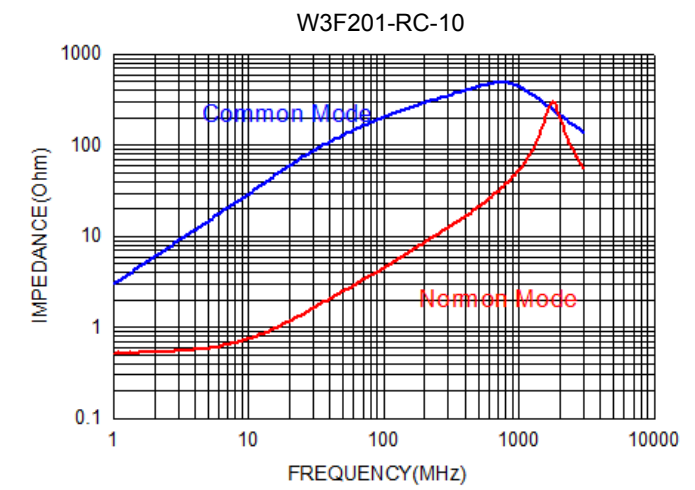
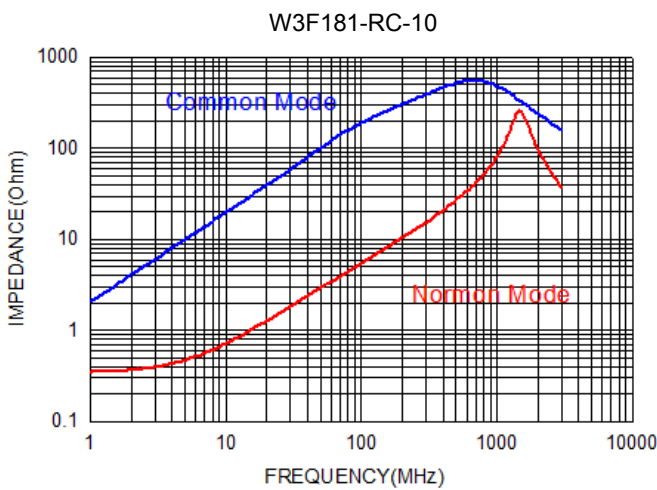
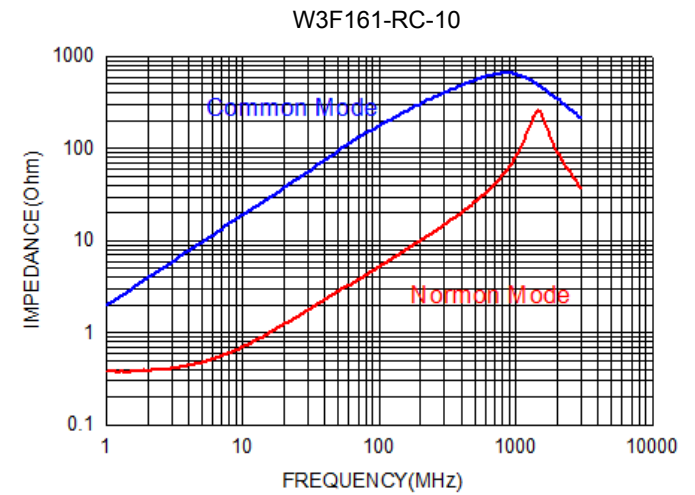
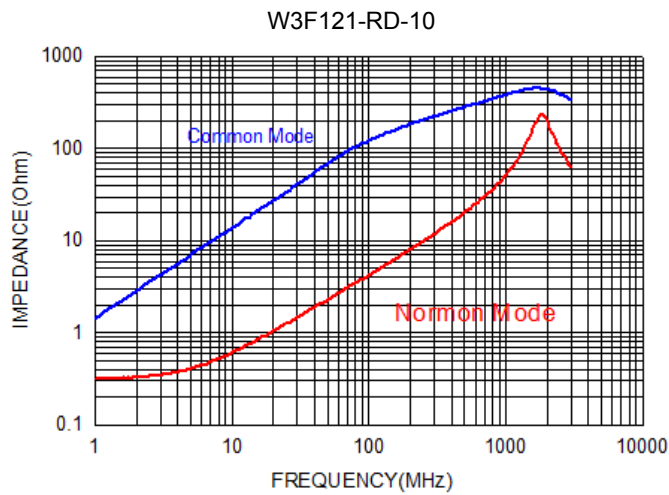
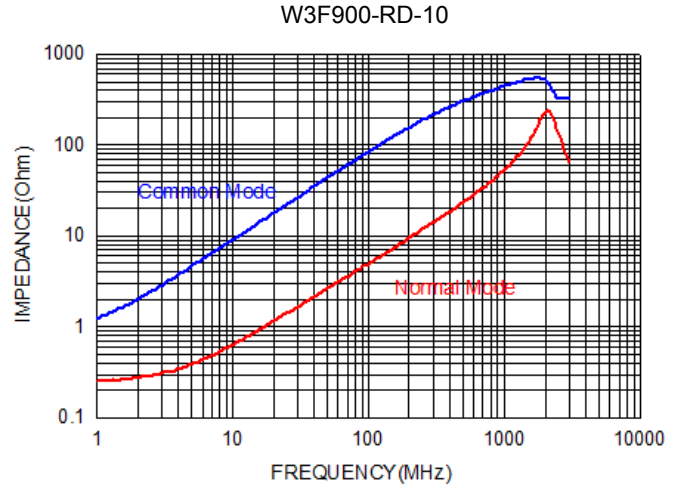
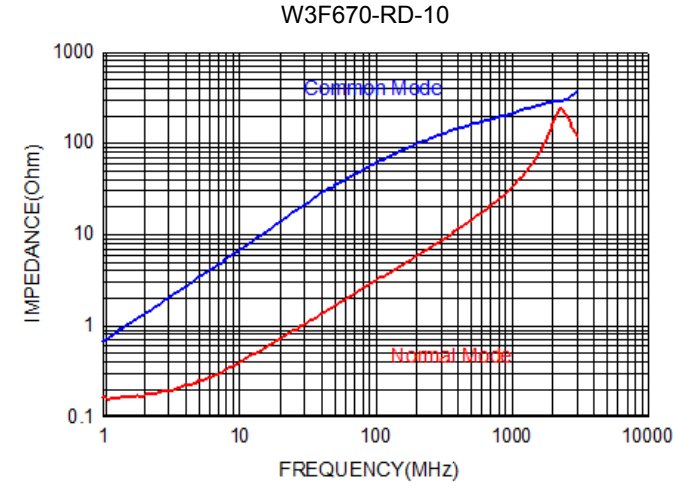

NOTE: Specifications subject to change without notice. Please check our website for latest information.



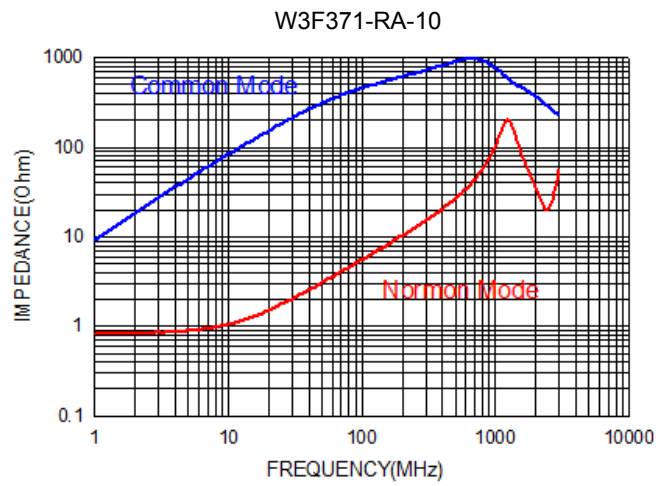
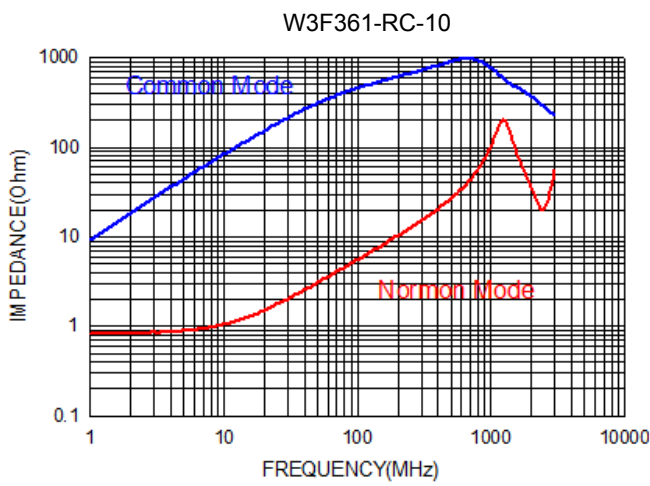
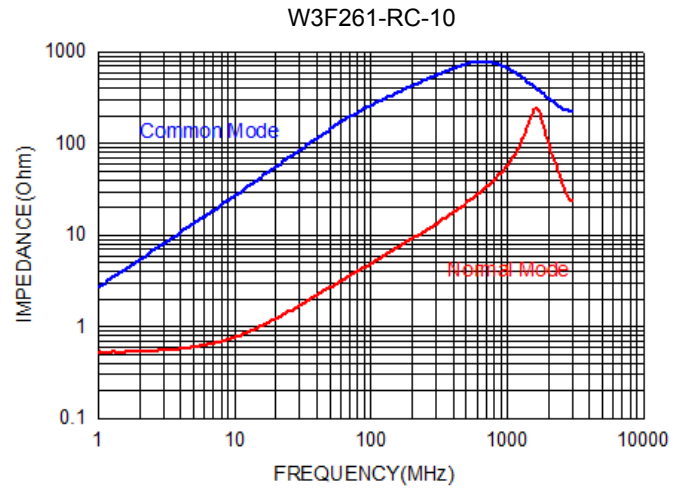
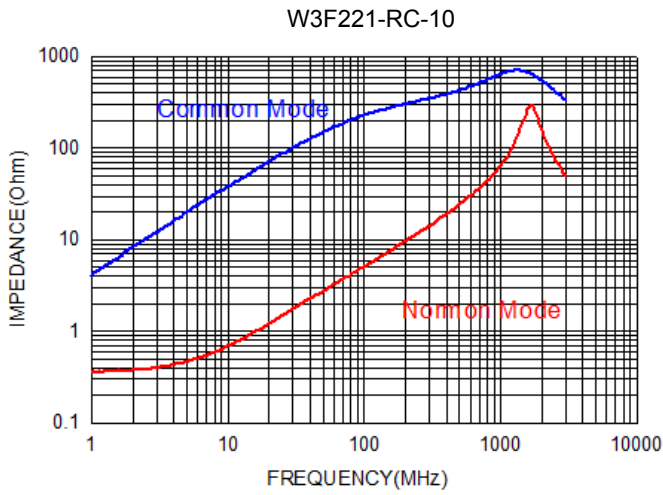

7-2 Insertion Loss Test

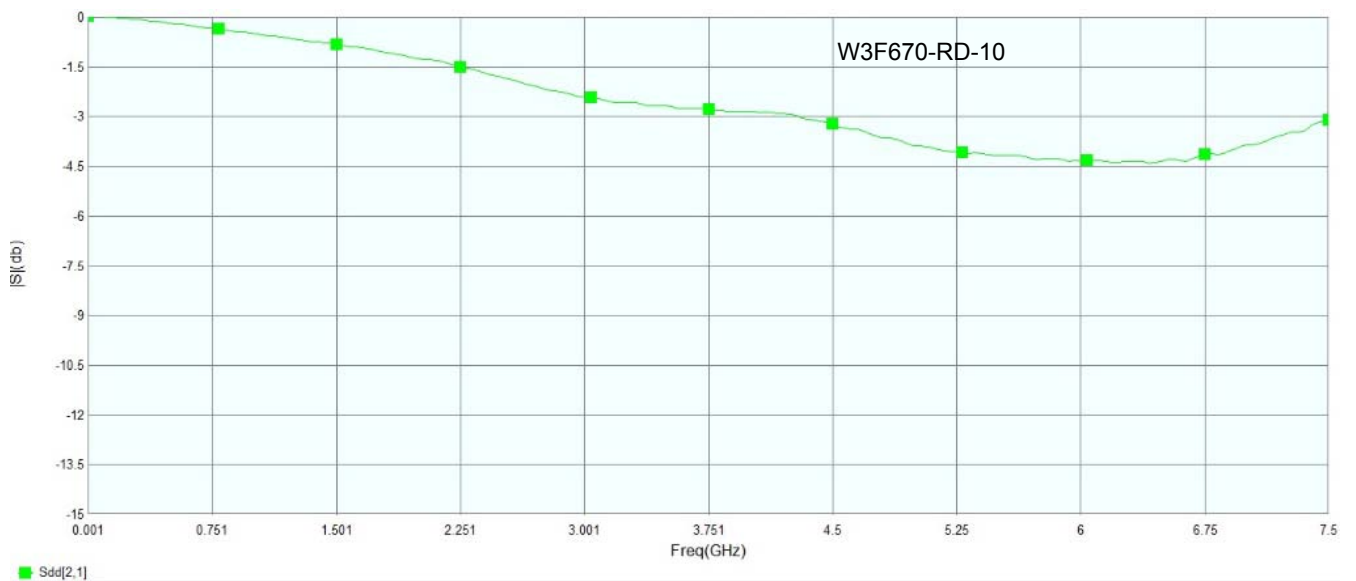

NOTE: Specifications subject to change without notice. Please check our website for latest information.

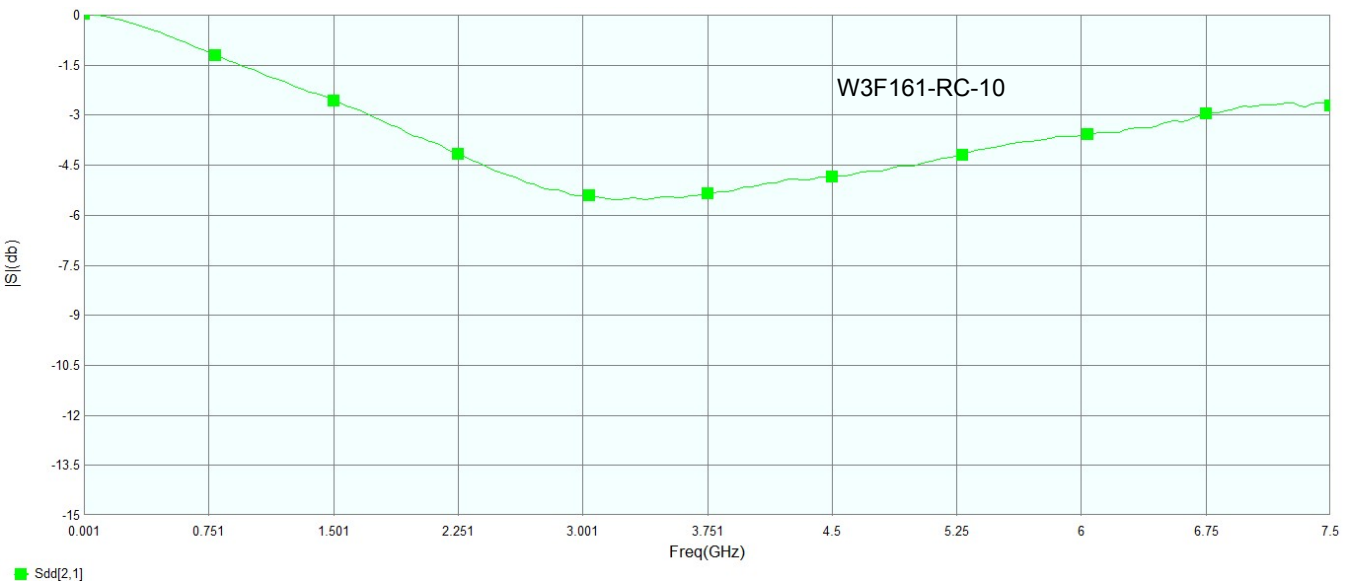
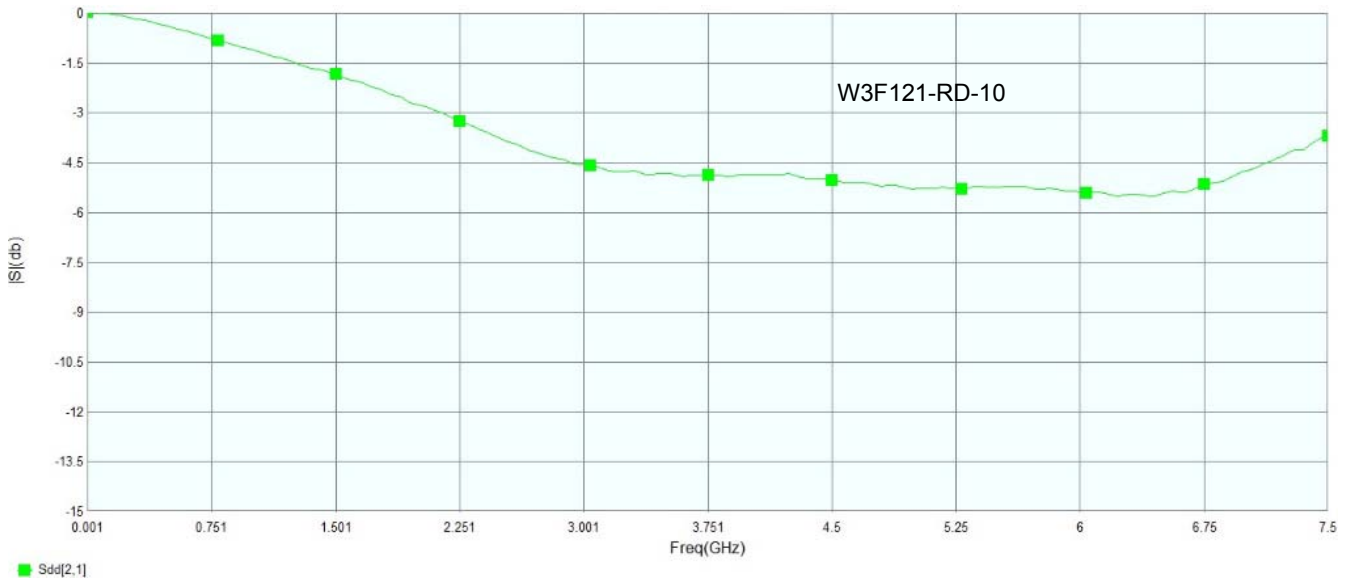
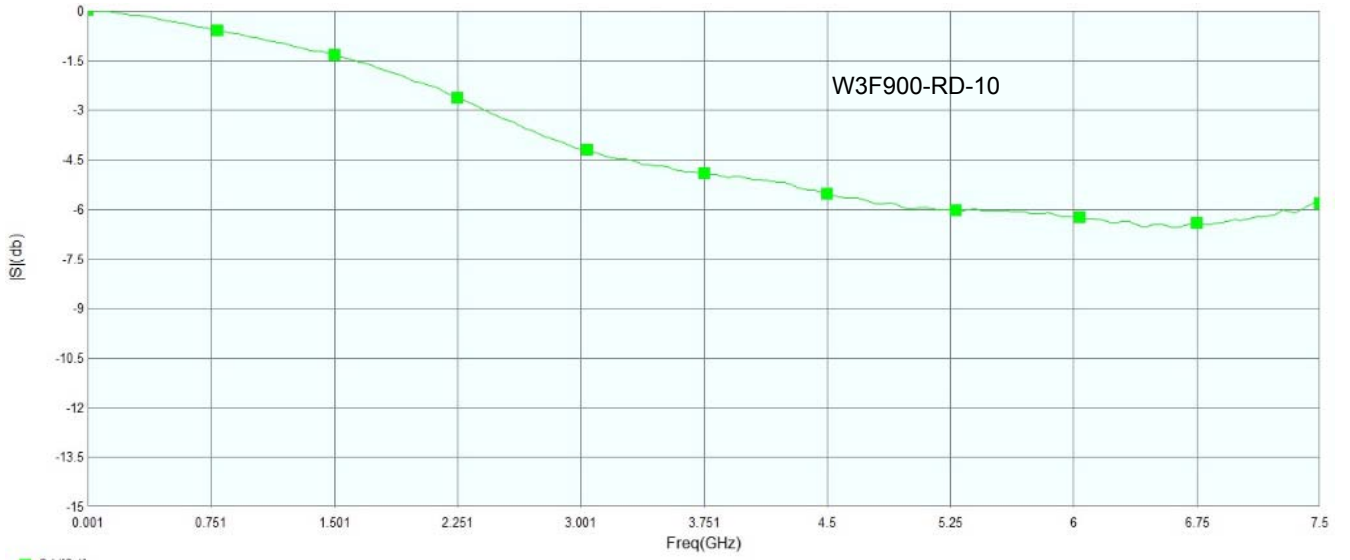

NOTE: Specifications subject to change without notice. Please check our website for latest information.



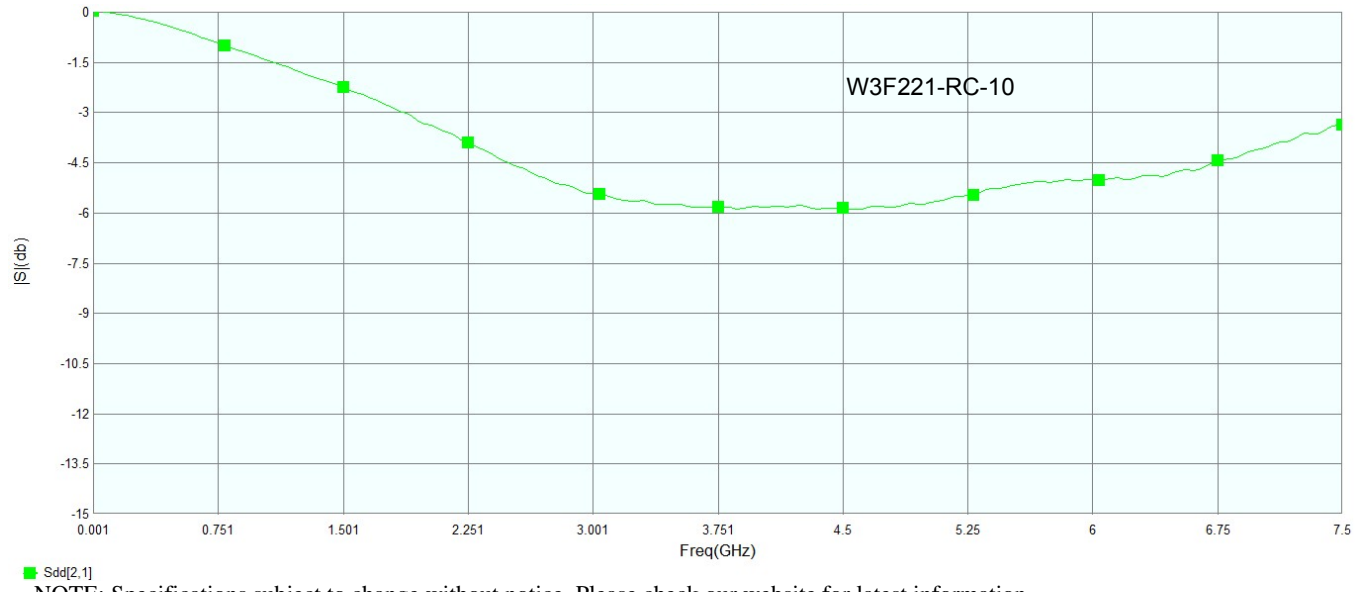
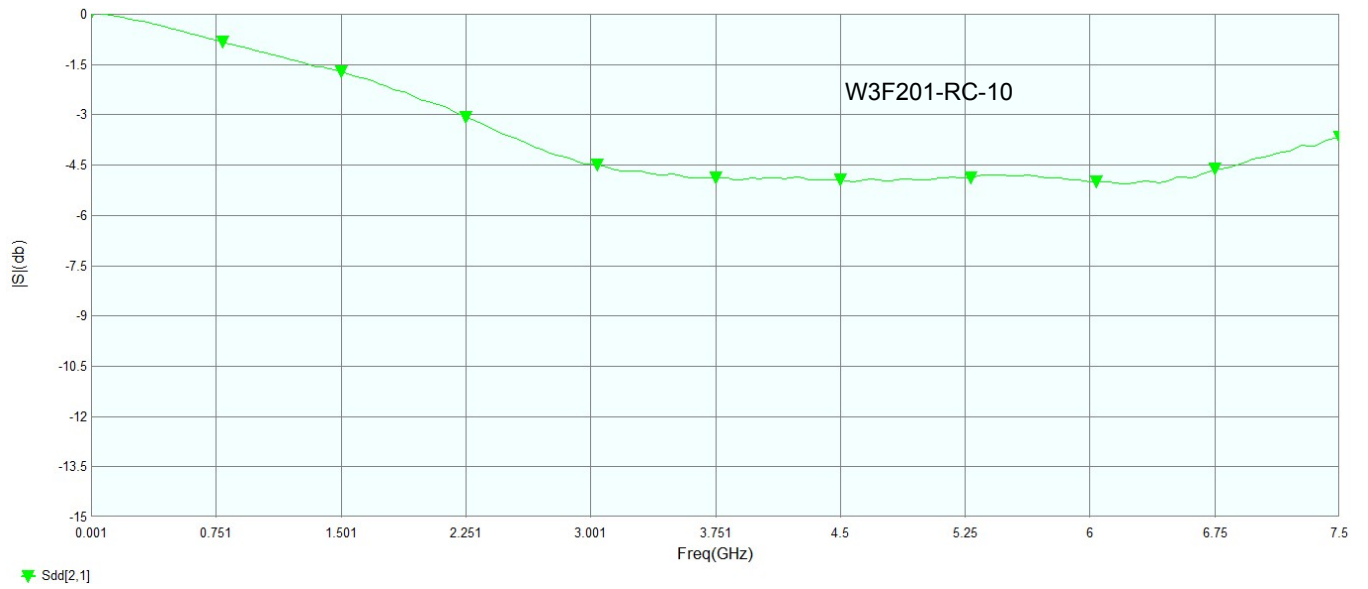
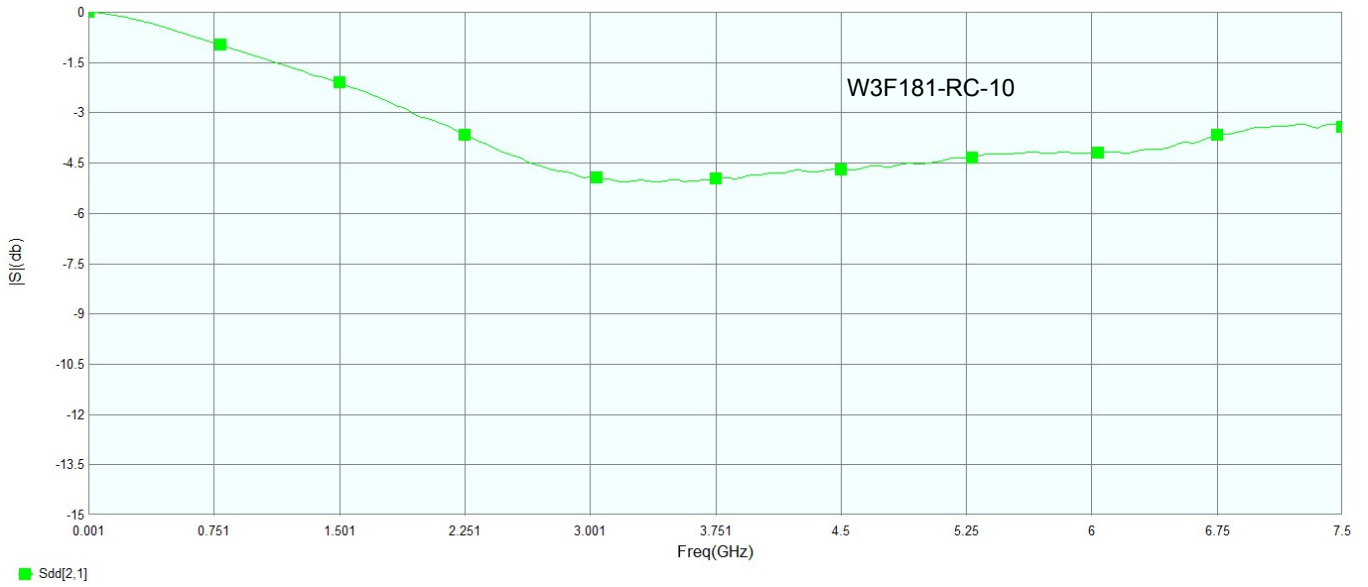

NOTE: Specifications subject to change without notice. Please check our website for latest information.



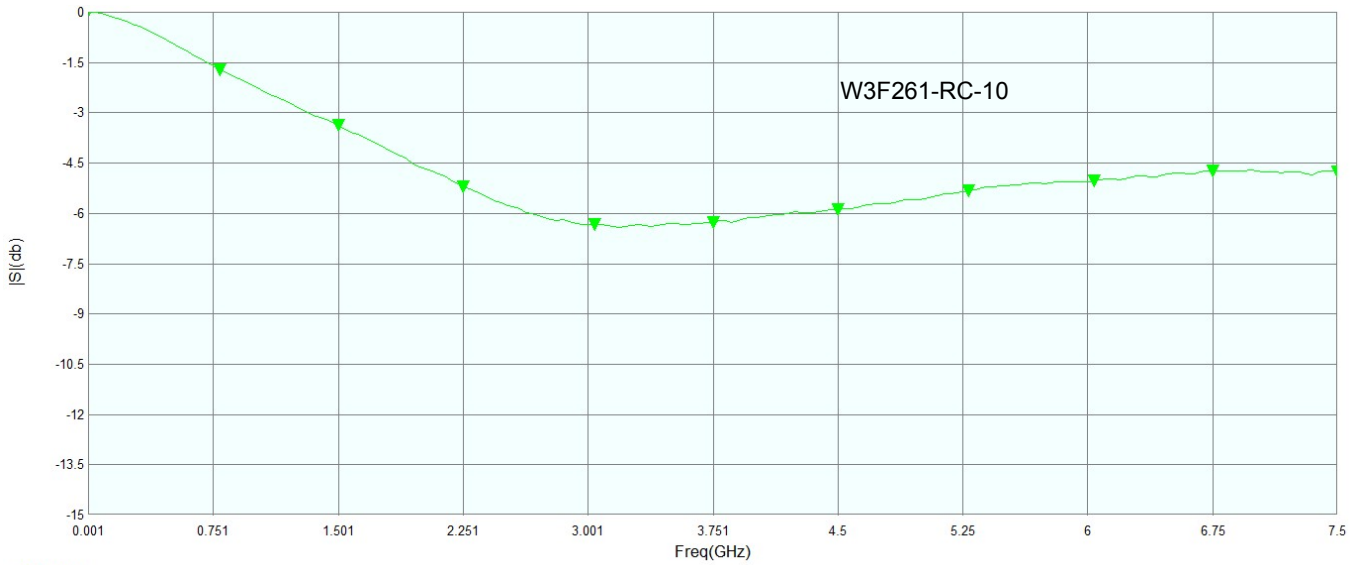

▼ Sdd[2,1]

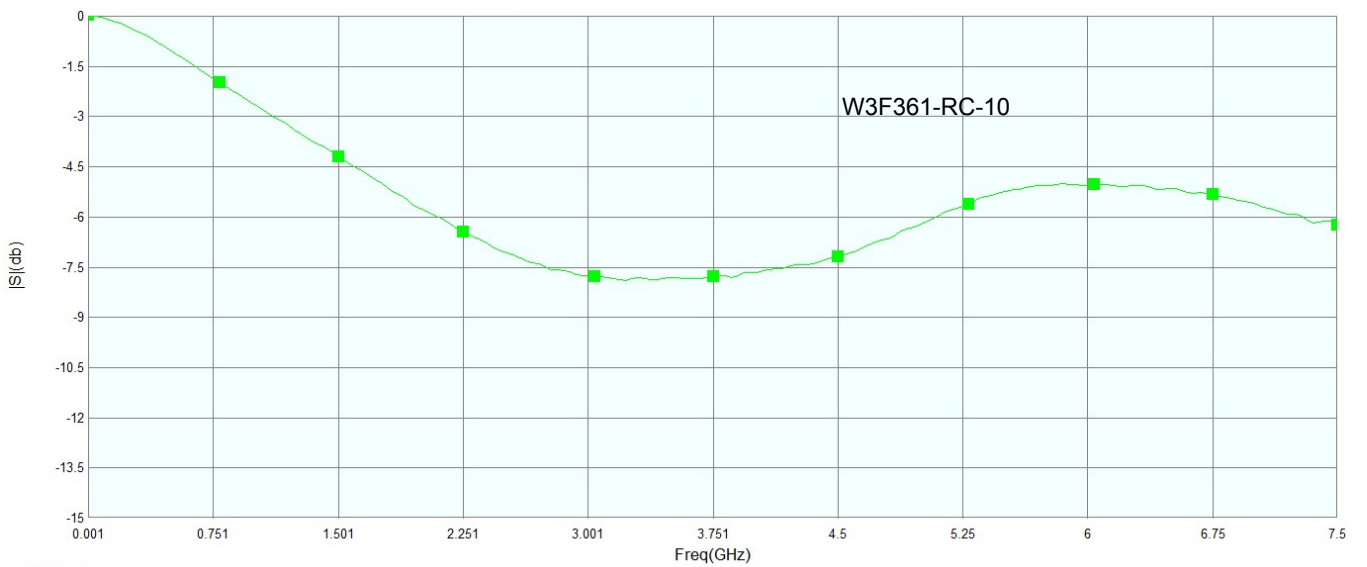

■ Sdd[2,1]

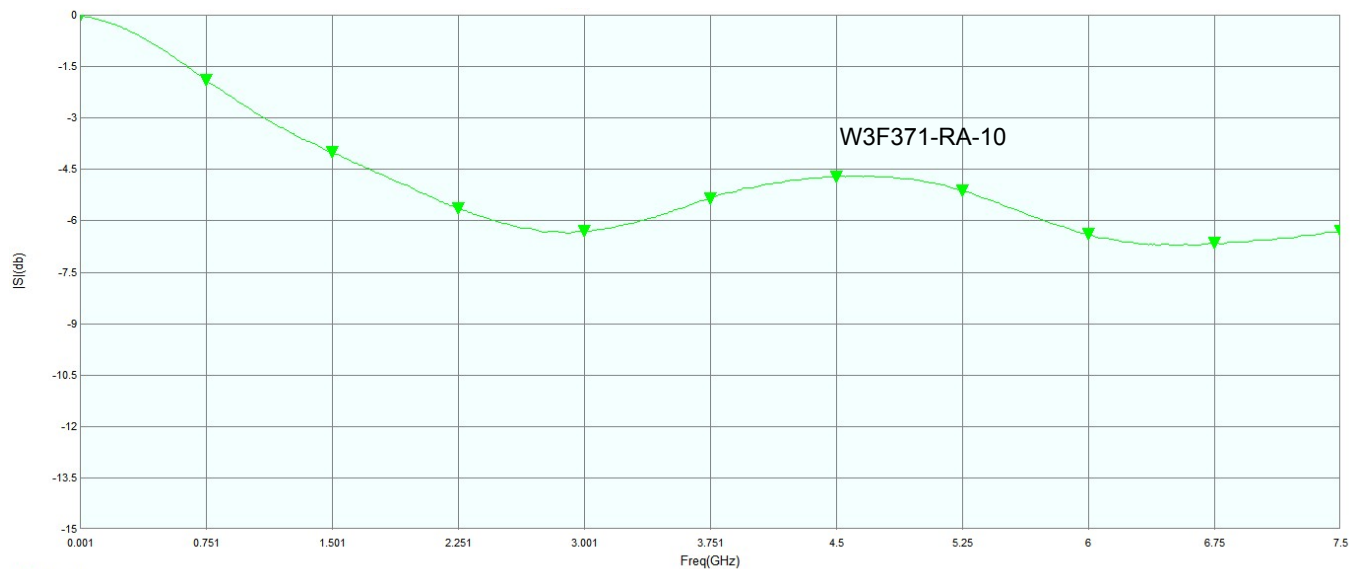

▼ Sdd[2,1]

NOTE: Specifications subject to change without notice. Please check our website for latest information.



8. Soldering

Mildly activated rosin fluxes are preferred. Our terminations are suitable for all re-flow soldering systems. If hand soldering cannot be avoided, the preferred technique is the utilization of hot air soldering tools.

8-1 Solder Re-flow:

Recommended temperature profiles for re-flow soldering in Figure 1.

8-2 Soldering Iron (Figure 2):

Products attachment with soldering iron is discouraged due to the inherent process control limitations. In the event that a soldering iron must be employed the following precautions are recommended.

Note :

- Preheat circuit and products to 150°C.
- 355°C tip temperature (Max.)
- Never contact the ceramic with the iron tip
- 1.0mm tip diameter (Max.)
- Use a 20 watt soldering iron with tip diameter of 1.0mm
- Limit soldering time to 4~5 sec.

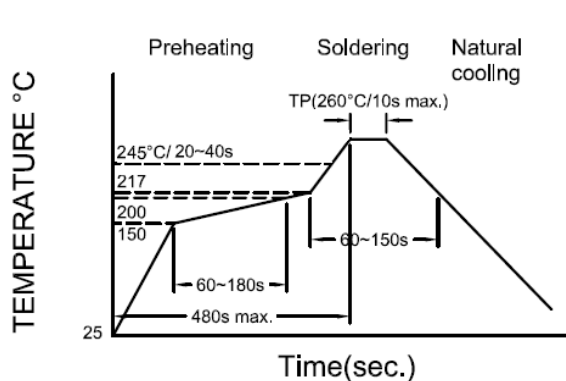

Figure 1 : Re-flow Soldering time
3 times max

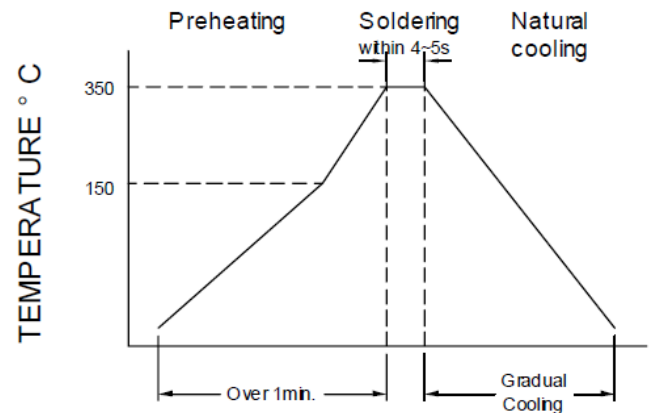
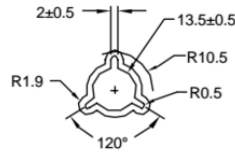
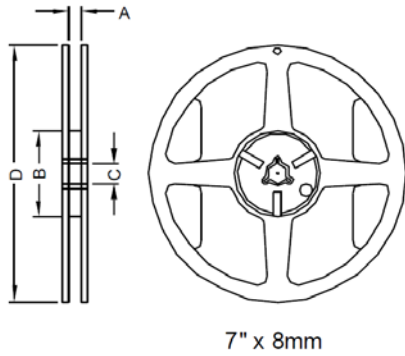

Figure 2 : Iron Soldering time
1 times max

NOTE: Specifications subject to change without notice. Please check our website for latest information.

9. Packaging Information:

9-1 Reel Dimension



Type	A(mm)	B(mm)	C(mm)	D(mm)
7"x8mm	9.0±0.5	60.0±2.0	13.5±0.5	178.0±2.0

9-2 Tape Dimension

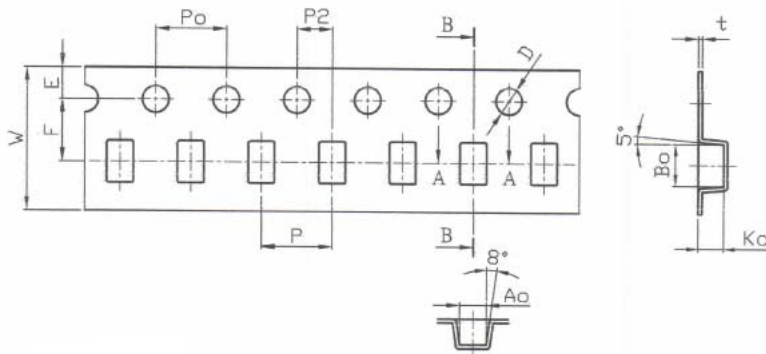

Size	W(mm)	P(mm)	E(mm)	F(mm)	P2(mm)	D(mm)	P0(mm)	A0(mm)	B0(mm)	K0(mm)	t(mm)
W3	8.00±0.10	4.00±0.10	1.75±0.10	3.50±0.05	2.00±0.05	1.50+0.10/-0.00	4.00±0.10	1.50±0.10	2.35±0.10	1.45±0.10	0.28±0.05

9-3 Packaging Quantity

Chip Size	W3
Chip/Reel	2,000
Inner Box	10,000
Middle Box	50,000
Carton	100,000

NOTE: Specifications subject to change without notice. Please check our website for latest information.

9-4 Tearing Off Force

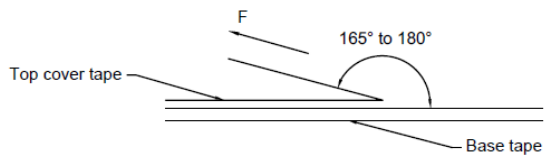

The force for tearing off cover tape is 15 to 80 grams in the arrow direction under the following conditions.

Room Temp. (°C)	Room Humidity (%)	Room atm (hPa)	Tearing Speed mm/min
5~35	45~85	860~1060	300

Application Notice:

1. Storage Conditions:

To maintain the solderability of terminal electrodes:

- a) Recommended products should be used within 12 months from the time of delivery.
- b) The packaging material should be kept where no chlorine or sulfur exists in the air.

2. Transportation:

- a) Products should be handled with care to avoid damage or contamination from perspiration and skin oils.
- b) Vacuum pick up is strongly recommended for individual components.
- c) Bulk handling should ensure that abrasion and mechanical shock are minimized.

NOTE: Specifications subject to change without notice. Please check our website for latest information.