

1. Part No. Expression:

**W 5 F 9 0 0 - R J - 1 0**

(a) (b)(c) (d) (e)(f) (g)

- (a) Series Code
- (b) Dimension Code
- (c) Material Code
- (d) Impedance Code
- (e) Packaging Code
- (f) Current Rating Code
- (g) Internal Controlled Number

2. Configuration & Dimensions:

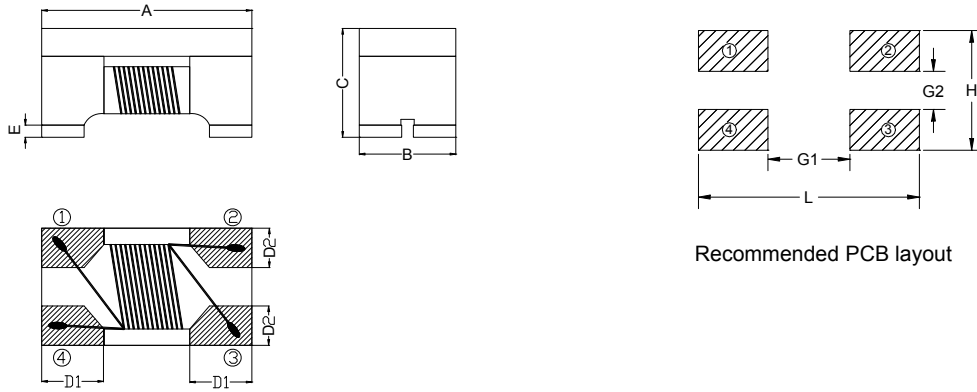

Unit: mm

A	B	C	D1	D2	E	L	G1	G2	H
3.2±0.2	2.5±0.2	2.2±0.2	0.8±0.1	0.9±0.1	0.15±0.1	4.4 Ref.	1.6 Ref.	0.6 Ref.	3.5 Ref.

3. Schematic:

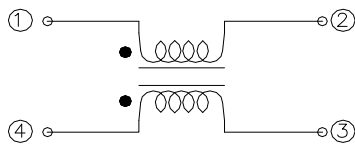

NOTE: Specifications subject to change without notice. Please check our website for latest information.

#### 4. Material List:

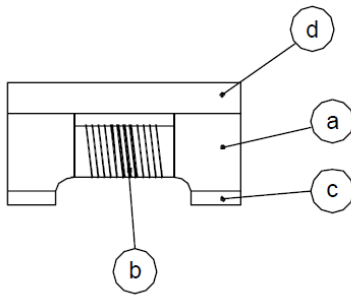

- (a) Core
- (b) Wire
- (c) Terminal
- (d) Upper Plate

#### 5. General Specification:

- (a) Operating Temp. : -40°C to +125°C(Including self - temperature rise)
- (b) Storage Temp. : -40°C to +125°C (on board)
- (c) Humidity Range: 85 ± 2% RH
- (d) Storage Condition (Component in its packaging)
  - i) Temperature: Less than 40°C
  - ii) Humidity : 60% RH

#### 6. Electrical Characteristics:

Part Number	Common Mode Impedance (Ω) ±25%	Test Frequency (MHz)	DCR (Ω) Max.	Rated Current (mA) Max.	Rated Volt (Vdc) Max.	Withstand Volt (Vdc) Max.	IR (Ω) Min.
W5F900-RJ-10	90	100	0.05	1000	50	125	10M
W5F601-RJ-10	600	100	0.20	1000	50	125	10M
W5F102-RD-10	1000	100	0.30	400	50	125	10M

NOTE: Specifications subject to change without notice. Please check our website for latest information.

7. Characteristics Curves:

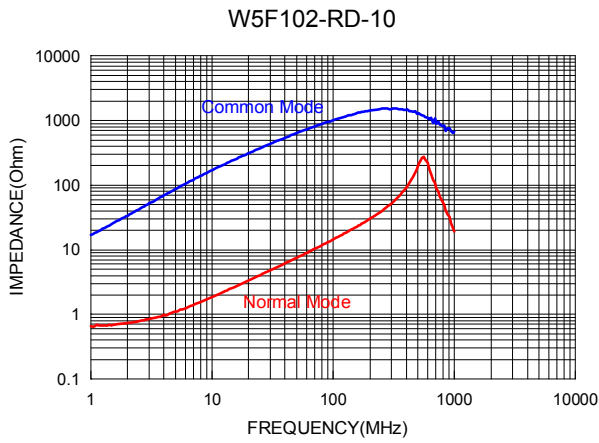
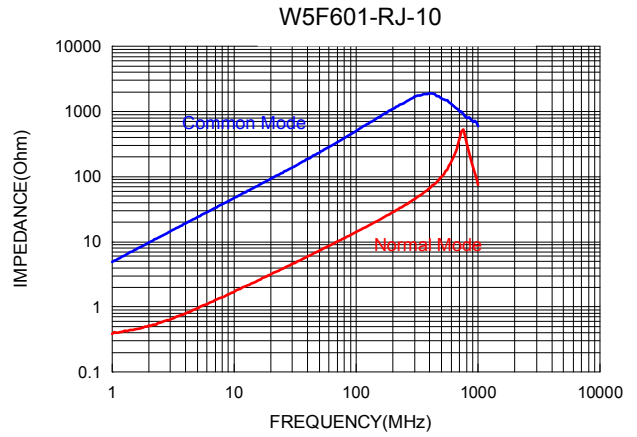
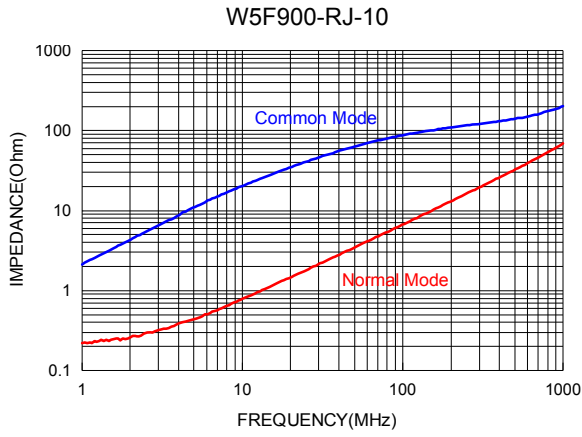

NOTE: Specifications subject to change without notice. Please check our website for latest information.



## 8. Soldering:

Mildly activated rosin fluxes are preferred. Our terminations are suitable for all re-flow soldering systems. If hand soldering cannot be avoided, the preferred technique is the utilization of hot air soldering tools.

### 8-1 Solder Re-flow

Recommended temperature profiles for re-flow soldering in Figure 1.

### 8-2 Soldering Iron (Figure 2)

Products attachment with soldering iron is discouraged due to the inherent process control limitations. In the event that a soldering iron must be employed the following precautions are recommended.

Note :

- Preheat circuit and products to 150°C.
- 355°C tip temperature (Max.)
- Never contact the ceramic with the iron tip
- 1.0mm tip diameter (Max.)
- Use a 20 watt soldering iron with tip diameter of 1.0mm
- Limit soldering time to 4~5 sec.

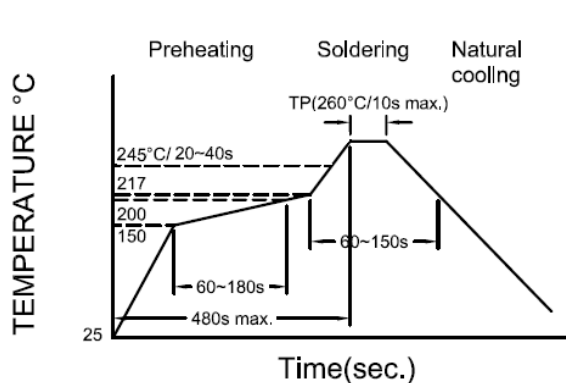

Figure 1. : Re-flow Soldering time  
3 times max

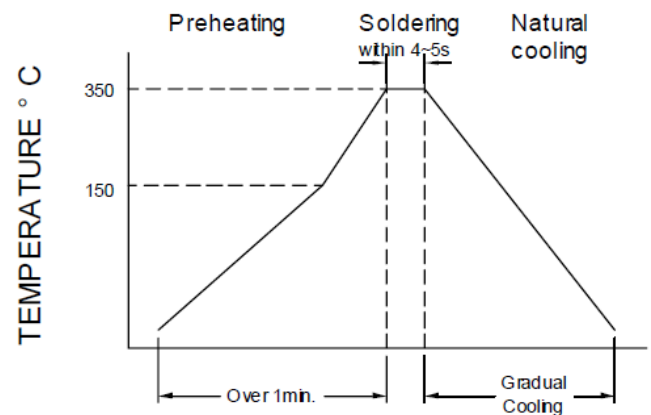
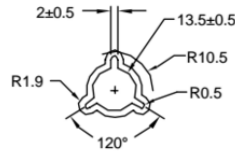
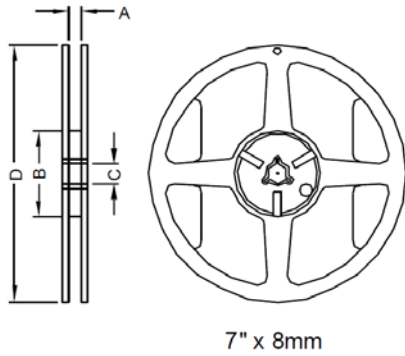

Figure 2. : Iron Soldering time  
1 times max

NOTE: Specifications subject to change without notice. Please check our website for latest information.

9. Packaging Information:

9-1 Reel Dimension



Type	A(mm)	B(mm)	C(mm)	D(mm)
7"x8mm	9.0±0.5	60.0±2.0	13.5±0.5	178.0±2.0

9-2 Tape Dimension

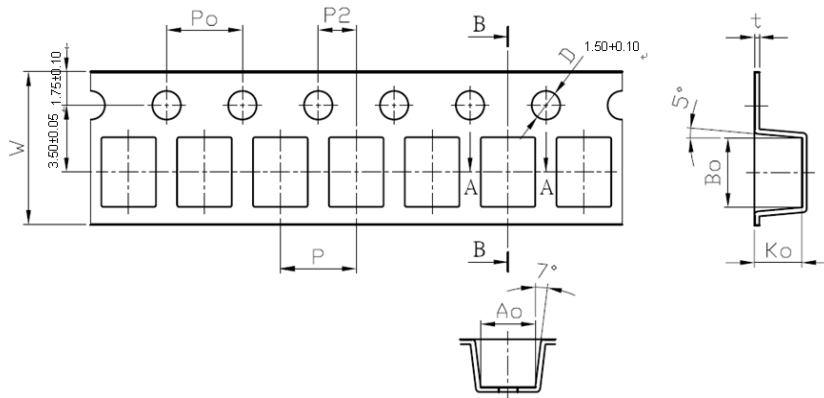

Size	P(mm)	Po(mm)	P2(mm)	Bo(mm)	Ao(mm)	Ko(mm)	W(mm)	t(mm)
W5F	4.00±0.10	4.00±0.10	2.00±0.05	3.65±0.10	2.88±0.10	2.50±0.10	8.00±0.10	0.26±0.05

9-3 Packaging Quantity

Chip Size	W5F
Chip/Reel	2,000
Inner Box	10,000
Middle Box	50,000
Carton	100,000

NOTE: Specifications subject to change without notice. Please check our website for latest information.



## 9-4 Tearing Off Force

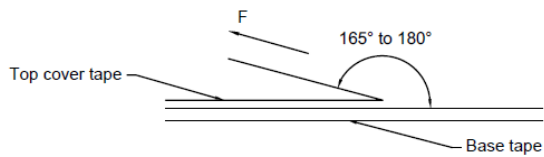

The force for tearing off cover tape is 15 to 80 grams in the arrow direction under the following conditions.

Room Temp. (°C)	Room Humidity (%)	Room atm (hPa)	Tearing Speed mm/min
5~35	45~85	860~1060	300

**Application Notice:**

## 1. Storage Conditions:

To maintain the solderability of terminal electrodes:

- a) Recommended products should be used within 12 months from the time of delivery.
- b) The packaging material should be kept where no chlorine or sulfur exists in the air.

## 2. Transportation:

- a) Products should be handled with care to avoid damage or contamination from perspiration and skin oils.
- b) Vacuum pick up is strongly recommended for individual components.
- c) Bulk handling should ensure that abrasion and mechanical shock are minimized.

NOTE: Specifications subject to change without notice. Please check our website for latest information.