

1. Part No. Expression:

Z Q 2 C 1 0 0 - R G - 1 0

(a) (b) (c) (d) (e) (f) (g)

- (a) Series Code
- (b) Dimension Code
- (c) Material Code
- (d) Impedance Code
- (e) Packaging Code
- (f) Current Code
- (g) Internal Code

2. Configuration & Dimensions:

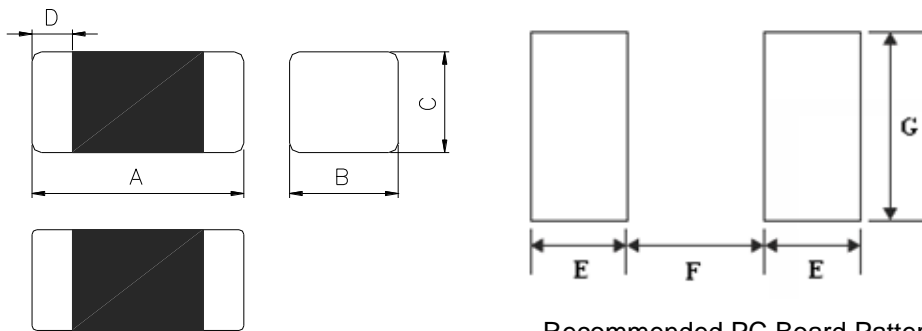

Recommended PC Board Pattern

Unit: mm

A	B	C	D	E	F	G
1.60±0.15	0.80±0.15	0.80±0.15	0.30±0.20	0.80 Ref.	0.85 Ref.	0.95 Ref.

3. Schematic:

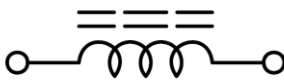

4. Material List:

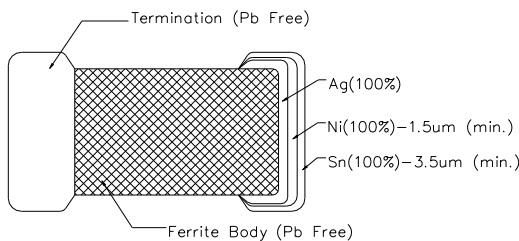

NOTE: Specifications subject to change without notice. Please check our website for latest information.



5. General Specifications:

- (a) Operating Temp. : -55°C to +150°C (including self-temperature rise)
- (b) Transportation Storage Temp. : -55°C to +150°C (on board)
- (c) Temperature Rise: Rated Current < 1A ΔT 20°C Max.
- (d) Storage Condition (Component in its packaging)
 - i) Temperature: Less than 40°C
 - ii) Humidity: 60% RH

6. Electrical Characteristics:

Part Number	Impedance (Ω)	Test Frequency (MHz)	DC Resistance (Ω) Max.	Rated Current (mA) Max.
ZQ2C100 - RG - 10	10±25%	100	0.20	700
ZQ2C300 - RF - 10	30±25%	100	0.25	600
ZQ2C600 - RF - 10	60±25%	100	0.30	600
ZQ2C121 - RC - 10	120±25%	100	0.40	300
ZQ2C221 - RC - 10	220±25%	100	0.60	250
ZQ2C301 - RB - 10	300±25%	100	0.80	200
ZQ2C601 - RB - 10	600±25%	100	1.20	150
ZQ2C102 - RA - 10	1000±25%	100	1.50	80

NOTE: Specifications subject to change without notice. Please check our website for latest information.



7. Characteristics Curves:

ZQ2C100 - RG - 10

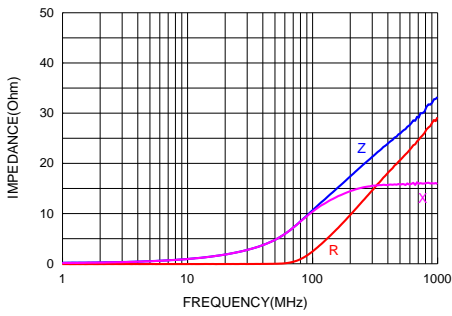

ZQ2C300 - RF - 10

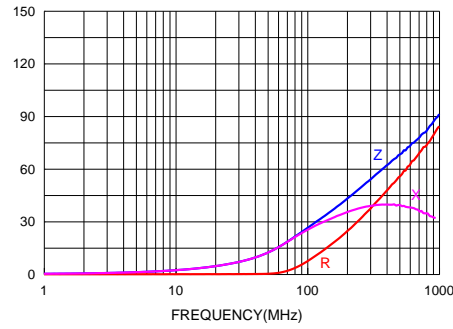

ZQ2C600 - RF - 10

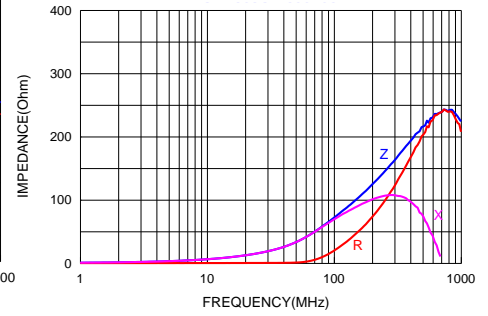

ZQ2C121 - RC - 10

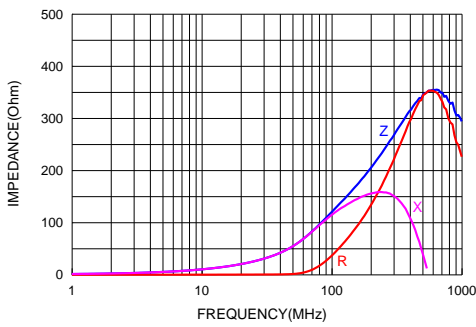

ZQ2C221 - RC - 10

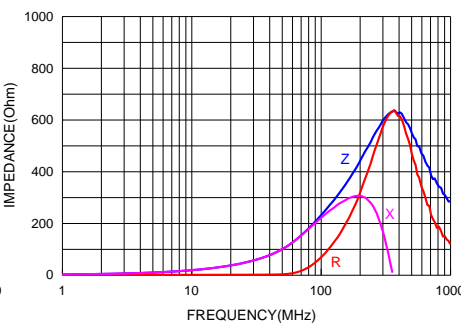

ZQ2C301 - RB - 10

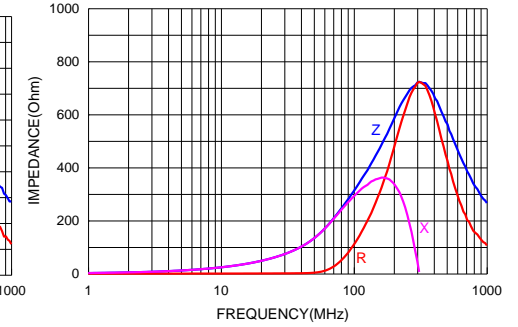

ZQ2C601 - RB - 10

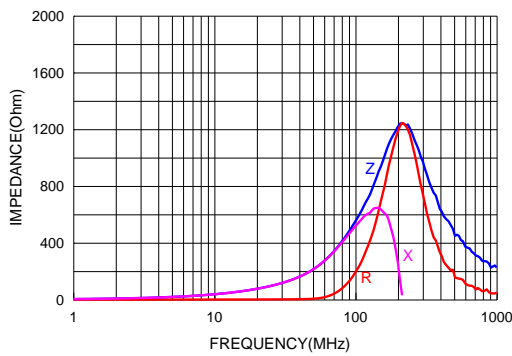

ZQ2C102 - RA - 10

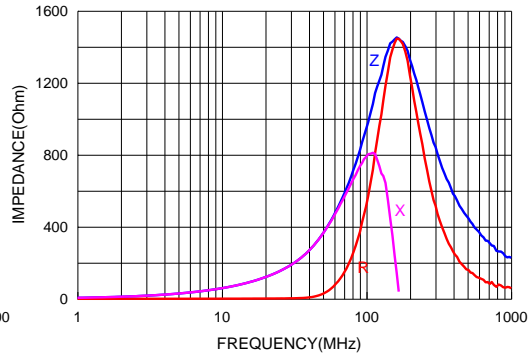

NOTE: Specifications subject to change without notice. Please check our website for latest information.



8. Soldering and Mounting:

Mildly activated rosin fluxes are preferred. Our terminations are suitable for all re-flow soldering systems. In hand soldering cannot be avoided, the preferred technique is the utilization of hot air soldering tools.

Note.

If wave soldering is used, there will be some risk.

Re-flow soldering temperatures below 240 degrees, there will be non-wetting risk

8.1 Solder Re-flow:

Recommended temperature profiles for re-flow soldering in Figure 1.

8.2 Soldering Iron (Figure 2):

Products attachment with soldering iron is discouraged due to the inherent process control limitations. In the event that a soldering iron must be employed the following precautions are recommended.

Note:

- a) Preheat circuit and products to 150°C.
- b) 350°C tip temperature (max.)
- c) Never contact the ceramic with the iron tip
- d) 1.0mm tip diameter (max.)
- e) Use a 20 watt soldering iron with tip diameter of 1.0mm
- f) Limit soldering time to 4~5 sec.

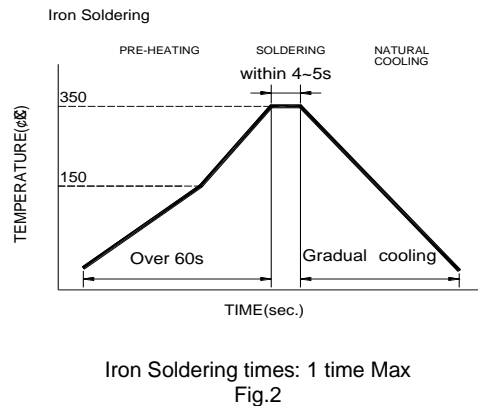
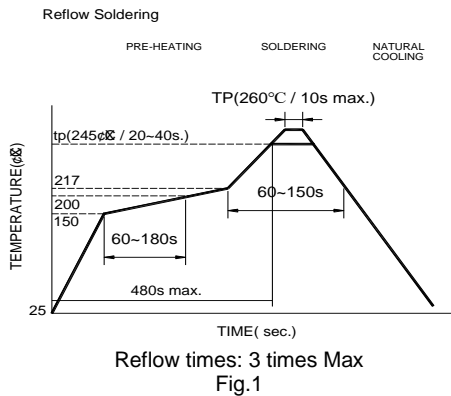

8.3 Soldering Volume:

Accordingly increasing the solder volume, the mechanical stress to product is also increased. Exceeding solder volume may cause the failure or mechanical or electrical performance. Solder shall be used not to be exceeding as shown in the Figure below. Minimum fillet height = soldering thickness + 25% product height.

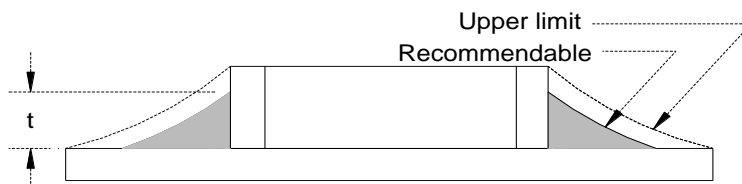

NOTE: Specifications subject to change without notice. Please check our website for latest information.



9. Packaging Information:

9-1 Reel Dimension

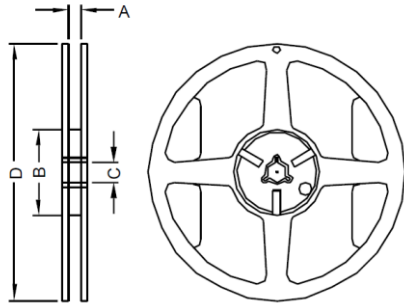

7" x 8mm

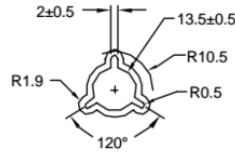

Type	A(mm)	B(mm)	C(mm)	D(mm)
7"x8mm	9.0±0.5	60.0±2.0	13.5±0.5	178.0±2.0

9-2 Tape Dimension

■ Material of taping is paper

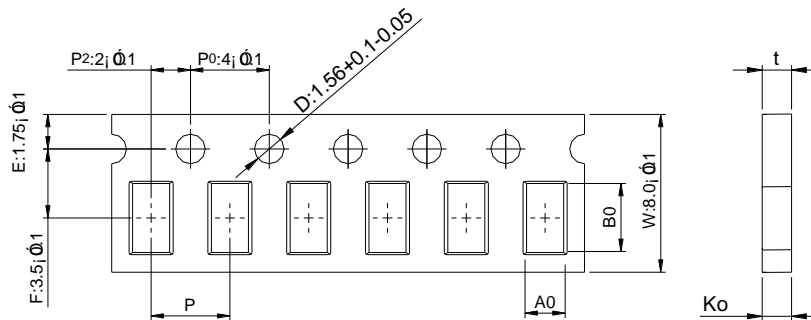

Size	Bo(mm)	Ao(mm)	Ko(mm)	P(mm)	t(mm)
ZQ2C	1.80±0.05	0.96+0.05/-0.03	0.95±0.05	4.0±0.10	0.95±0.05

9-3 Packaging Quantity

Chip Size	ZQ2C
Chip/Reel	4000
Inner Box	20000
Middle Box	100000
Carton	200000

NOTE: Specifications subject to change without notice. Please check our website for latest information.



9-4 Tearing Off Force

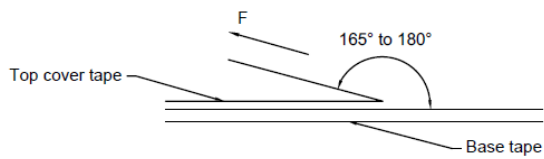

The force for tearing off cover tape is 15 to 60 grams in the arrow direction under the following conditions.

Room Temp. (°C)	Room Humidity (%)	Room atm (hPa)	Tearing Speed mm/min
5~35	45~85	860~1060	300

Application Notice:

1. Storage Conditions:

To maintain the solderability of terminal electrodes:

- a) Recommended products should be used within 12 months from the time of delivery.
- b) The packaging material should be kept where no chlorine or sulfur exists in the air.

2. Transportation:

- a) Products should be handled with care to avoid damage or contamination from perspiration and skin oils.
- b) Vacuum pick up is strongly recommended for individual components.
- c) Bulk handling should ensure that abrasion and mechanical shock are minimized.

NOTE: Specifications subject to change without notice. Please check our website for latest information.