

## 1. Part No. Expression:

**PIA 1 2 6 5 S P 1 R 0 M N**

(a) (b) (c) (d) (e)(f)

a) Series Code

b) Dimension Code

c) Type Code

d) Inductance Code

e) Tolerance Code

f) Internal Control Code

## 2. Configuration & Dimensions:

### a. Lead Frame

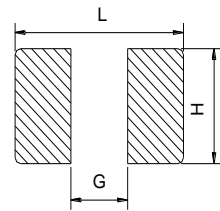
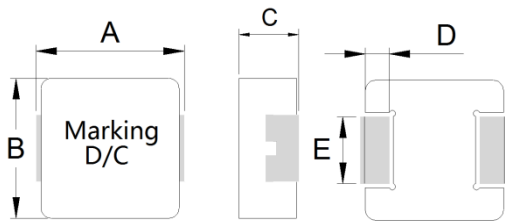

Recommend PC Board Pattern

### b. Non Lead Frame

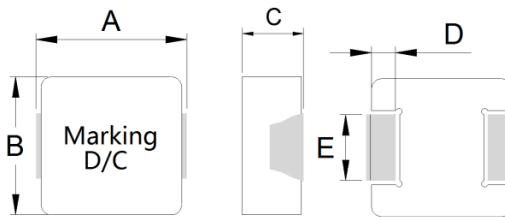

Note:

1. The above PCB layout is for reference only.
2. Solder paste thickness of 0.15mm and above is recommended.
3. Marking: Top row – Inductance code, Bottom row – Year/World week.

Unit: mm

A	B	C	D	L	G	H	E	Inductance
13.5±0.5	12.6±0.2	6.2±0.3	2.3±0.3	14.5 Ref.	8.0 Ref.	5.0 Ref.	4.0±0.3	0.56~1.50uH among
							4.7±0.3	0.47uH and below 1.80uH and above

## 3. Schematic:

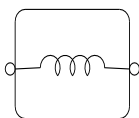

NOTE: Specifications subject to change without notice. Please check our website for latest information.

## 4. Material List:

### i) Lead Frame

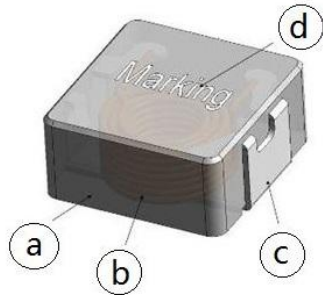

### ii) Non-lead Frame

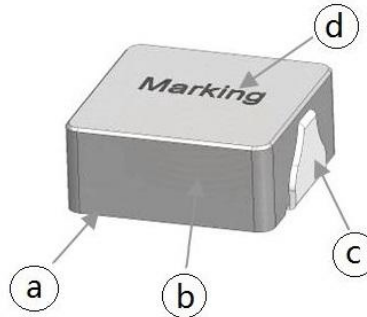

- a) Core
- b) Wire
- c) Terminal
- d) Ink

## 5. General Specification:

- (a) Operating Temp. : -40°C to +125°C (Inclusive of coil temp rise).
- (b) Storage Temp. : -40°C to +125°C (on board).
- (c) Humidity Range. : 85 ± 2% RH.
- (d) Heat Rated Current (Irms) will cause the coil temperature rise approximately  $\Delta t$  of 40°C.
- (e) Saturation Current (Isat Typ.) will cause L0 to drop approximately 30%.
- (f) Part Temp. (Ambient + Temp. Rise) should not exceed 125°C under worst case operating conditions.
- (g) Storage condition (component in its packaging)
  - i) Temperature: Less than 40°C
  - ii) Humidity : 60% RH

NOTE: Specifications subject to change without notice. Please check our website for latest information.

## 6. Electrical Characteristics:

Part Number	Inductance Lo (uH) @ 0A	Test Frequency (Hz)	Heat Rating Current DC (A) Irms.		Saturation Current DC (A) Isat.		DCR (mΩ)Typ.	DCR (mΩ)Max.	Type
			Typ.	Max.	Typ.	Max.			
PIA1265SPR10YN	0.10	1.0V/100K	65.0	60.0	120	115	0.20	0.25	Non lead frame
PIA1265SPR22MN	0.22	1.0V/100K	53.0	42.0	112	105	0.40	0.46	Non lead frame
PIA1265SPR47MN	0.47	1.0V/100K	42.0	35.0	68.0	58.0	0.88	1.02	Non lead frame
PIA1265SPR56MN	0.56	1.0V/100K	37.0	33.5	57.0	50.0	1.10	1.30	Non lead frame
PIA1265SPR68MN	0.68	1.0V/100K	36.5	33.0	55.0	46.0	1.25	1.50	Non lead frame
PIA1265SPR82MN	0.82	1.0V/100K	35.0	31.0	48.0	39.0	1.30	1.65	Non lead frame
PIA1265SP1R0MN	1.00	1.0V/100K	33.0	29.0	45.0	36.0	1.50	1.80	Non lead frame
PIA1265SP1R2MN	1.20	1.0V/100K	31.0	27.0	38.0	33.0	1.80	2.20	Non lead frame
PIA1265SP1R5MN	1.50	1.0V/100K	29.0	25.0	35.0	30.0	2.20	2.53	Non lead frame
PIA1265SP1R8MN	1.80	1.0V/100K	27.0	23.0	31.0	27.0	3.20	3.60	Non lead frame
PIA1265SP2R2MN	2.20	1.0V/100K	25.0	21.0	28.5	24.0	3.70	4.20	Lead frame
PIA1265SP3R3MN	3.30	1.0V/100K	22.0	19.0	27.0	22.5	5.30	6.20	Lead frame
PIA1265SP4R7MN	4.70	1.0V/100K	20.0	17.0	25.0	21.0	6.80	8.00	Lead frame
PIA1265SP5R6MN	5.60	1.0V/100K	18.0	15.0	23.0	19.5	8.30	9.80	Lead frame
PIA1265SP6R8MN	6.80	1.0V/100K	16.5	14.0	21.0	18.0	9.80	11.3	Lead frame
PIA1265SP8R2MN	8.20	1.0V/100K	15.0	12.5	19.0	17.0	12.0	13.8	Lead frame
PIA1265SP100MN	10.0	1.0V/100K	13.0	11.0	17.0	15.0	13.0	15.8	Lead frame
PIA1265SP220MN	22.0	1.0V/100K	10.0	8.00	10.0	9.00	31.0	35.0	Lead frame
PIA1265SP330MN	33.0	1.0V/100K	9.00	6.50	9.00	8.00	46.0	55.0	Lead frame
PIA1265SP470MN	47.0	1.0V/100K	8.00	5.70	7.60	6.80	58.0	67.0	Lead frame
PIA1265SP680MN	68.0	1.0V/100K	5.80	4.80	6.00	5.00	82.0	100	Lead frame
PIA1265SP820MN	82.0	1.0V/100K	5.00	4.00	5.00	4.20	110	132	Lead frame
PIA1265SP101MN	100	1.0V/100K	5.00	3.80	5.00	4.00	140	161	Lead frame

\*Tolerance code : M =  $\pm 20\%$ , Y =  $\pm 30\%$

## Notes:

- 1) At all times, the current supplied to the product should not exceed Isat Max. value.

NOTE: Specifications subject to change without notice. Please check our website for latest information.



7. Characteristics Curves:

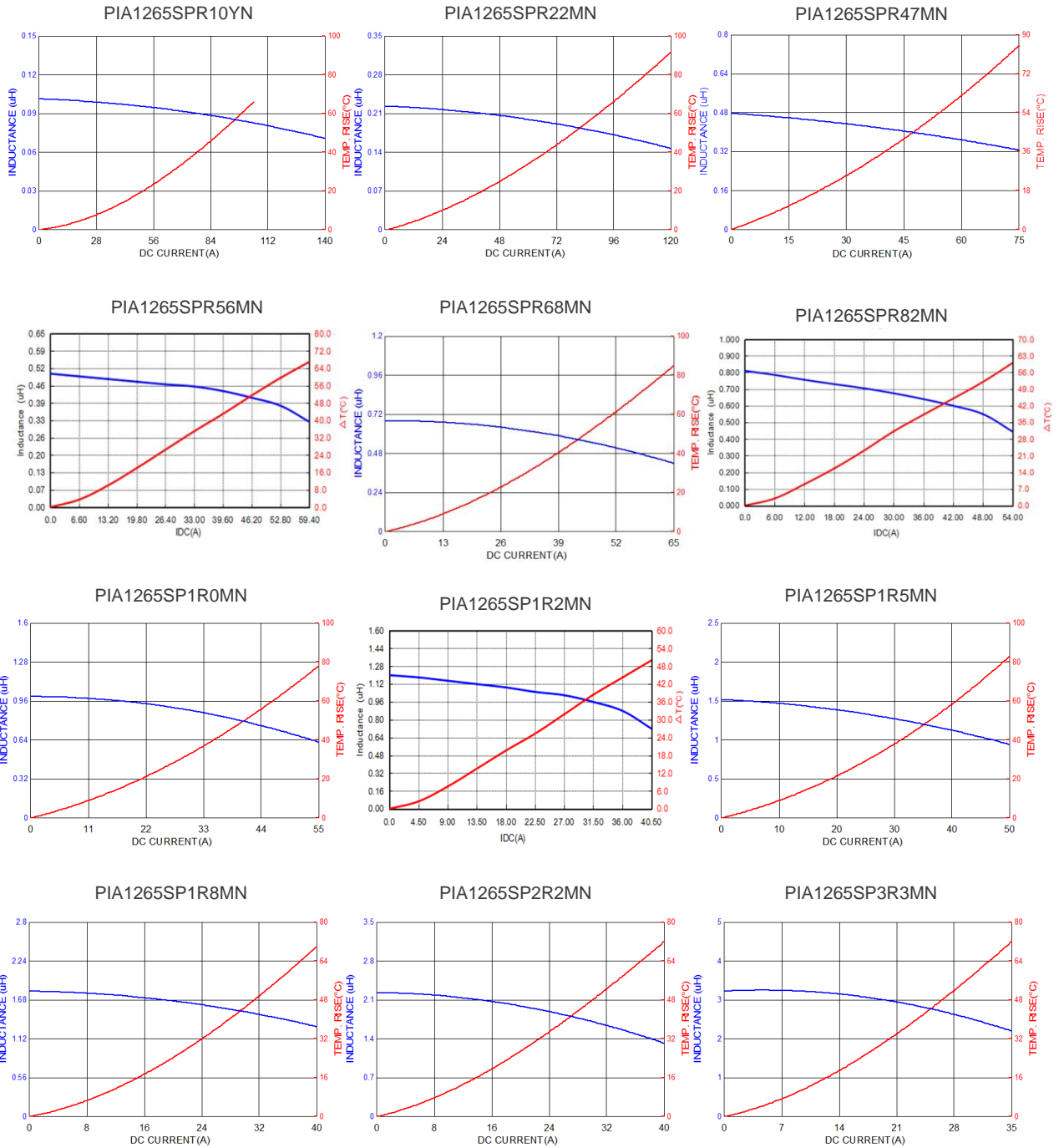

NOTE: Specifications subject to change without notice. Please check our website for latest information.



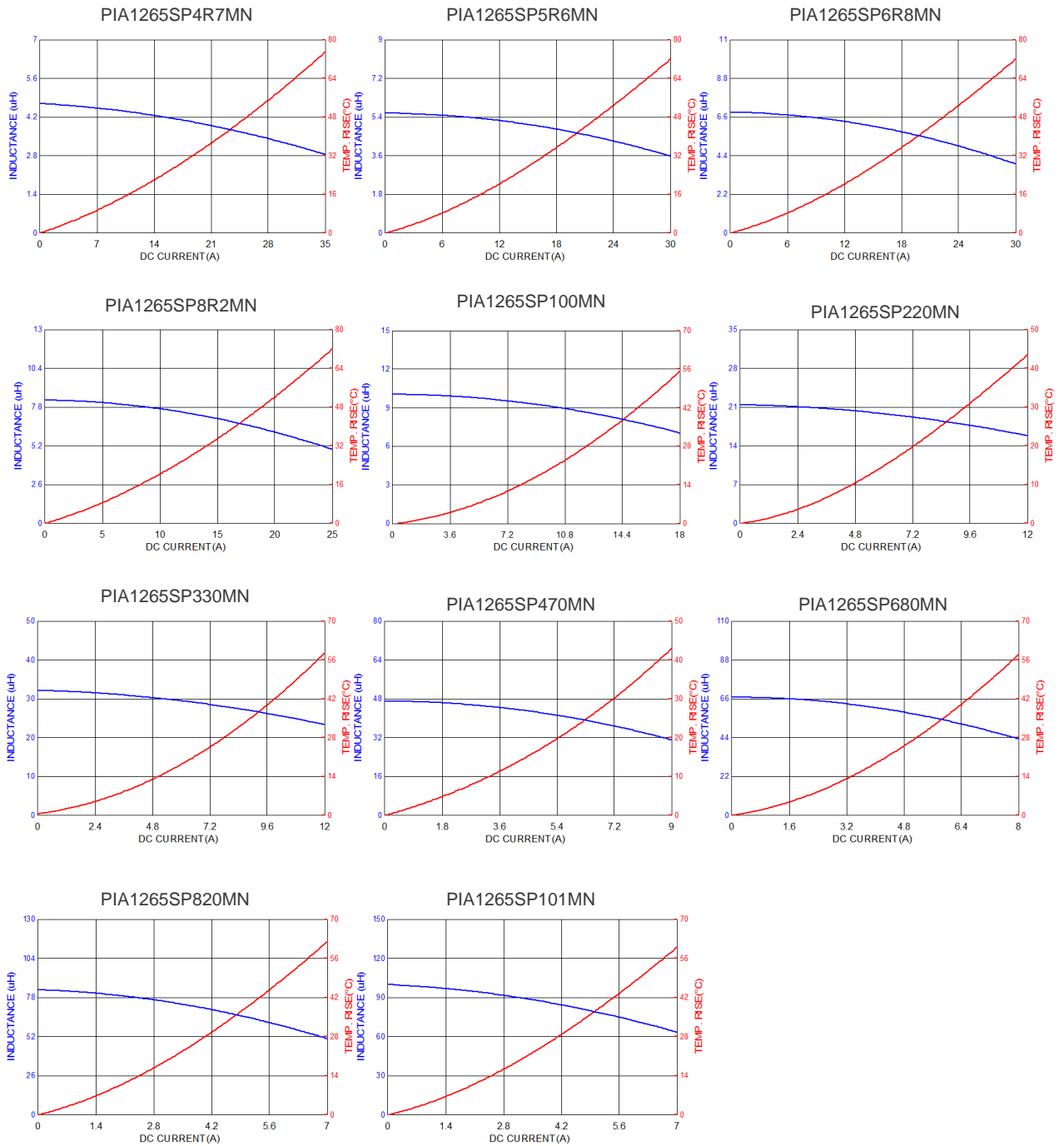

NOTE: Specifications subject to change without notice. Please check our website for latest information.



**8. Soldering:**

Mildly activated rosin fluxes are preferred. The minimum amount of solder can lead to damage from the stresses caused by the difference in coefficients of expansion between solder, chip and substrate. Our terminations are suitable for all re-flow soldering systems. If hand soldering cannot be avoided, the preferred technique is the utilization of hot air.

**8-1 Solder Re-flow:**

Recommended temperature profiles for re-flow soldering in Figure 1.

**8-2 Soldering Iron (Figure 2):**

Products attachment with soldering iron is discouraged due to the inherent process control limitations. In the event that a soldering iron must be employed the following precautions are recommended.

Note :

- a) Preheat circuit and products to 150°C.
- b) 355°C tip temperature (Max.)
- c) Never contact the ceramic with the iron tip
- d) 1.0mm tip diameter (Max.)
- e) Use a 20 watt soldering iron with tip diameter of 1.0mm
- f) Limit soldering time to 4~5 secs.

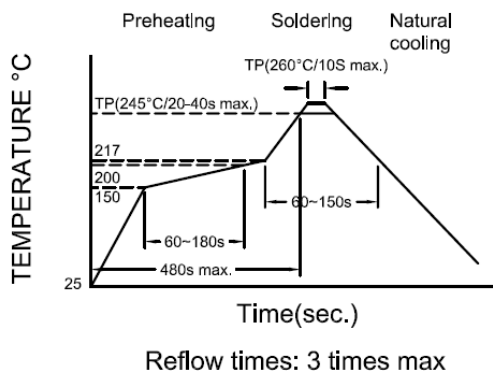

Reflow times: 3 times max

Fig.1

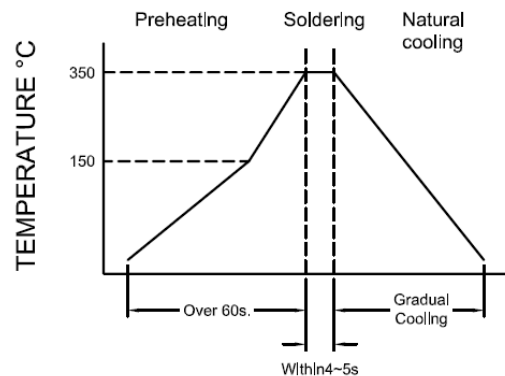

Iron Soldering times: 1 times max

Fig.2

NOTE: Specifications subject to change without notice. Please check our website for latest information.



9. Packaging Information:

9-1 Reel Dimension:

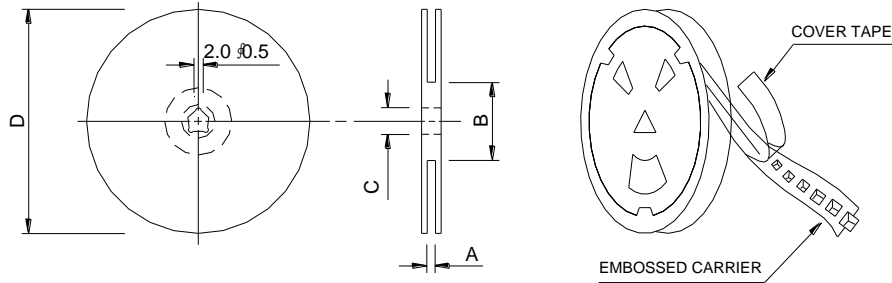

Type	A(mm)	B(mm)	C(mm)	D(mm)
13"x24mm	24.4+2/-0	100±2	13.5±0.5	330

9-2 Tape Dimension:

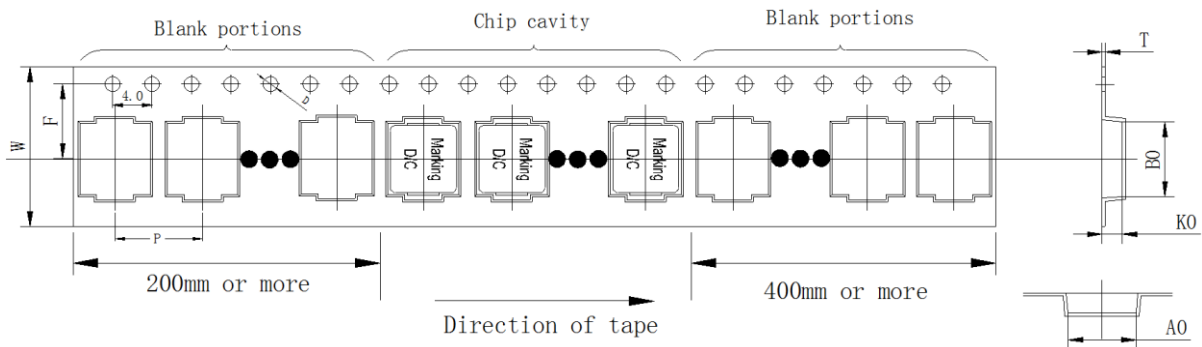

Series	Size	Bo(mm)	Ao(mm)	Ko(mm)	P(mm)	W(mm)	F(mm)	T(mm)	D(mm)
PIA	1265	14.1±0.1	12.9±0.1	7.0±0.1	16.0±0.1	24.0±0.3	11.5±0.1	0.35±0.05	1.5±0.1

9-3 Packaging Quantity:

PIA	1265
Chip / Reel	500
Inner box	1000
Carton	4000

NOTE: Specifications subject to change without notice. Please check our website for latest information.



## 9-4 Tearing Off Force:

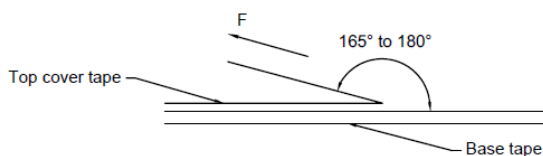

The force for tearing off cover tape is 10 to 130 grams in the arrow direction under the following conditions.

Room Temp. (°C)	Room Humidity (%)	Room atm (hPa)	Tearing Speed mm/min
5~35	45~85	860~1060	300

## Application Notice:

### 1. Storage Conditions:

To maintain the solderability of terminal electrodes:

- a) Recommended products should be used within 12 months from the time of delivery.
- b) The packaging material should be kept where no chlorine or sulfur exists in the air.

### 2. Transportation:

- a) Products should be handled with care to avoid damage or contamination from perspiration and skin oils.
- b) Vacuum pick up is strongly recommended for individual components.
- c) Bulk handling should ensure that abrasion and mechanical shock are minimized.

NOTE: Specifications subject to change without notice. Please check our website for latest information.