

1. Part No. Expression:

S P S 2 0 1 6 1 0 E R 2 4 M F

(a) (b) (c) (d) (e) (f)

- (a) Series code
- (b) Dimension code
- (c) Material code
- (d) Inductance code
- (e) Tolerance Code
- (f) RoHS Compliant

2. Configuration & Dimensions : (Unit: mm)

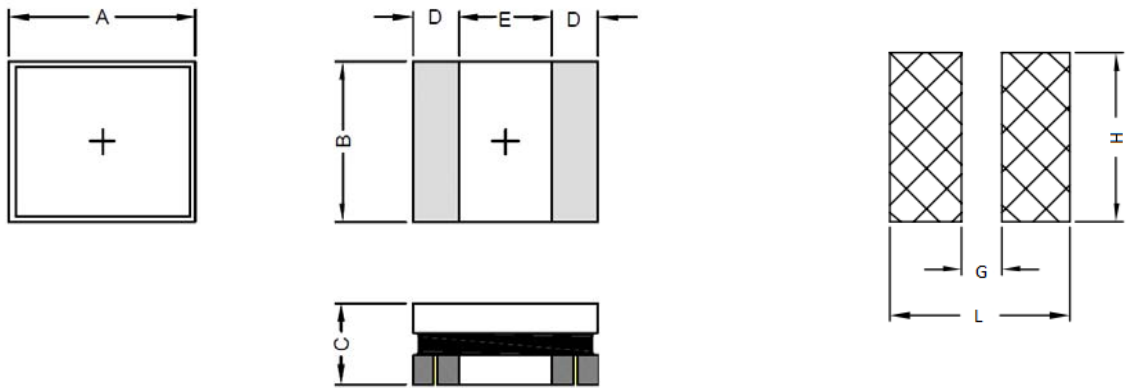

Recommended PCB Pattern

Unit : mm

A	B	C	D	E	G	H	L
2.0 -0.1/+0.2	1.6 -0.1/+0.2	1.00 Max.	0.60 Ref.	0.80 Ref.	0.70	1.70	2.30

3. Schematic



NOTE: Specifications subject to change without notice. Please check our website for latest information.

4. Material List

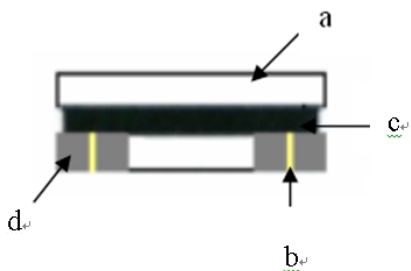

- a) Core
- b) Wire
- c) Glue
- d) Terminal

Exposed wire tolerance limit of coating resin part on product side:

1. Width direction (dimension a) : Acceptable when $a \leq w/2$;
Nonconforming when $a > w/2$
2. Length direction (dimension b): Dimension b is not specified
3. The total area of exposed wire occurring to each sides is not greater than 50% of coating resin area and is acceptable

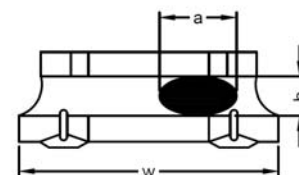

5. General Specification

- a) Isat: Based on inductance change ($\Delta L/L_0: \leq 30\%$ Typ.)
- b) Irms: Based on temperature rise ($\Delta T: 40^\circ\text{C Max.}$)
- c) Operating Temperature: -40°C to $+125^\circ\text{C}$ (including self-temperature rise)
- d) Storage Temperature: -40°C to $+125^\circ\text{C}$
- e) Storage Condition (component in its packaging)
 - i) Temperature: Less than 40°C
 - ii) Humidity: 60% RH

NOTE: Specifications subject to change without notice. Please check our website for latest information.

6. Electrical Characteristics

Part No.	Inductance (μH)	Test Frequency (Hz)	DCR (Ω) Max.	Isat (A) Max.	Irms (A) Max.
SPS201610ER12MF	0.12 ± 20%	0.1V/1M	0.026	6.00	4.50
SPS201610ER22MF	0.22 ± 20%	0.1V/1M	0.028	4.50	3.90
SPS201610ER24MF	0.24 ± 20%	0.1V/1M	0.028	4.50	3.90
SPS201610ER33MF	0.33 ± 20%	0.1V/1M	0.040	3.50	3.10
SPS201610ER47MF	0.47 ± 20%	0.1V/1M	0.042	3.40	3.00
SPS201610ER68MF	0.68 ± 20%	0.1V/1M	0.055	2.80	2.50
SPS201610E1R0MF	1.00 ± 20%	0.1V/1M	0.072	2.50	2.20
SPS201610E1R5MF	1.50 ± 20%	0.1V/1M	0.118	1.80	1.80
SPS201610E2R2MF	2.20 ± 20%	0.1V/1M	0.170	1.70	1.55
SPS201610E4R7MF	4.70 ± 20%	0.1V/1M	0.384	0.90	0.90

7. Characteristics Curves

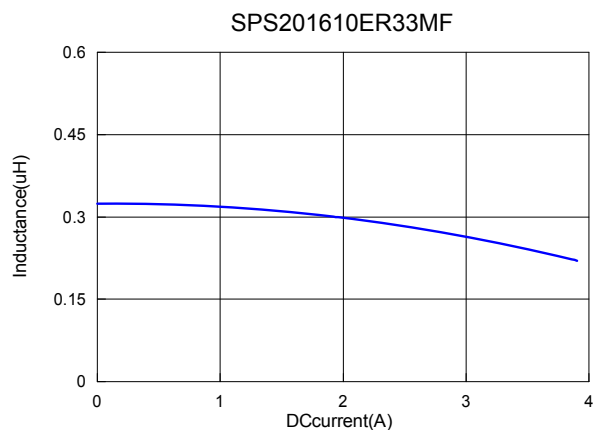
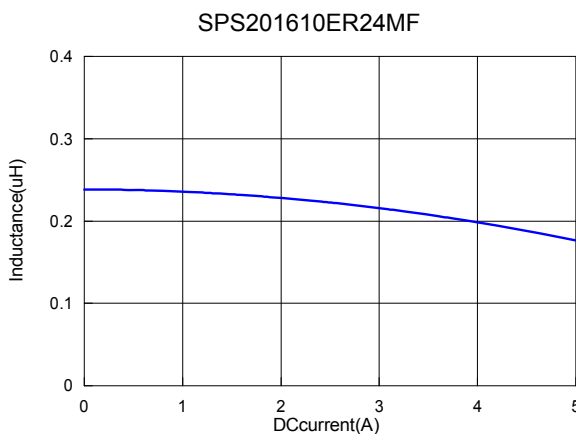
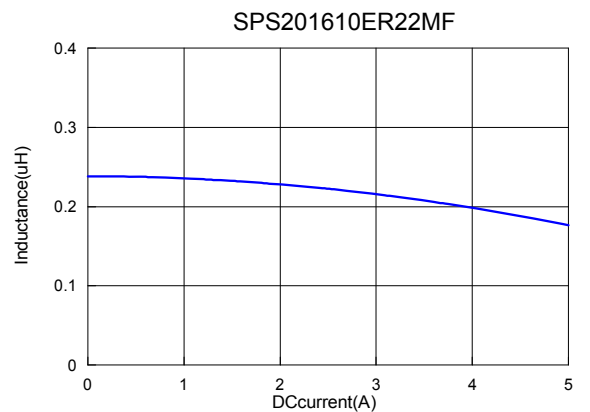
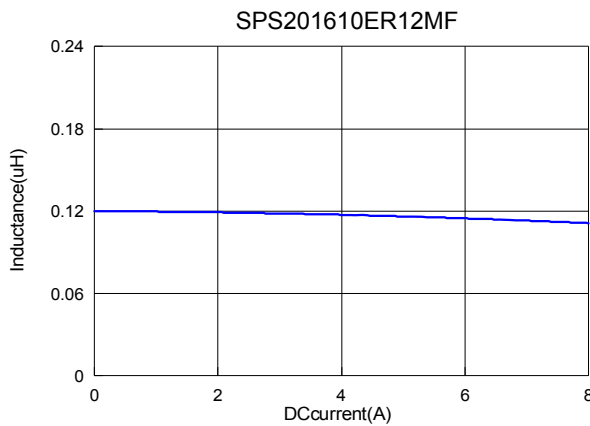

NOTE: Specifications subject to change without notice. Please check our website for latest information.

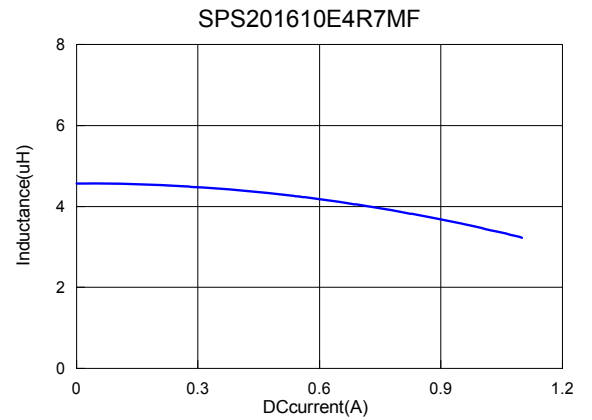
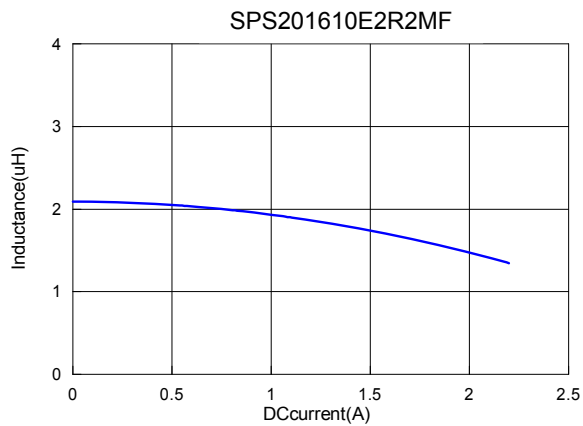
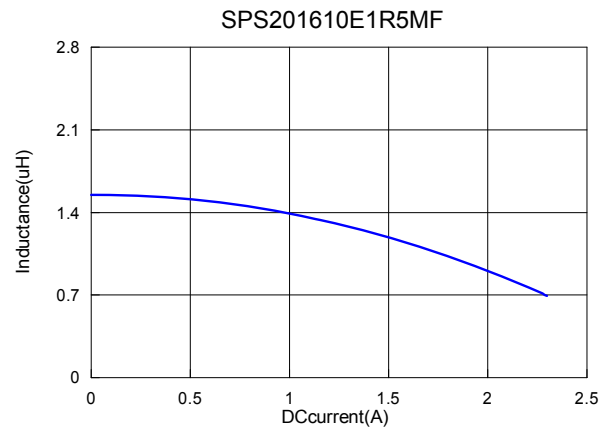
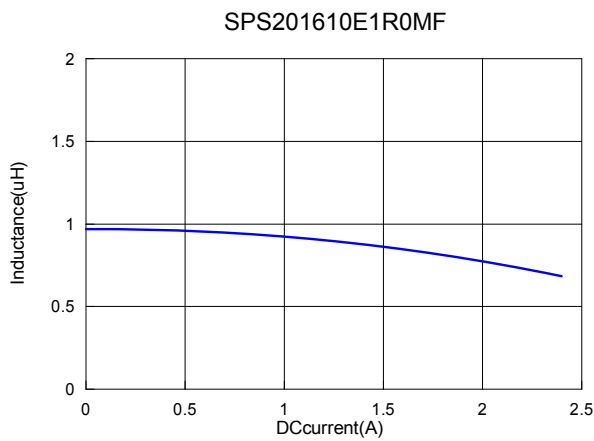
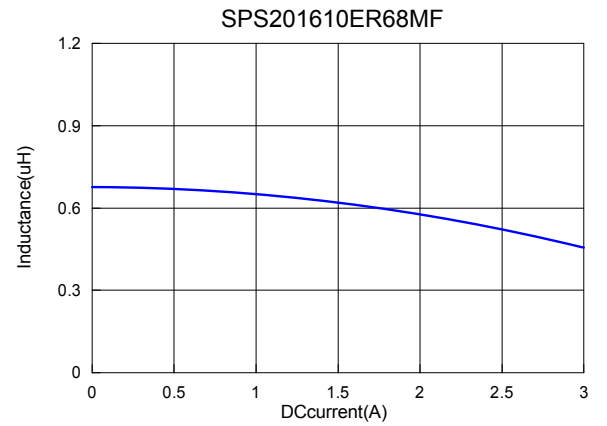
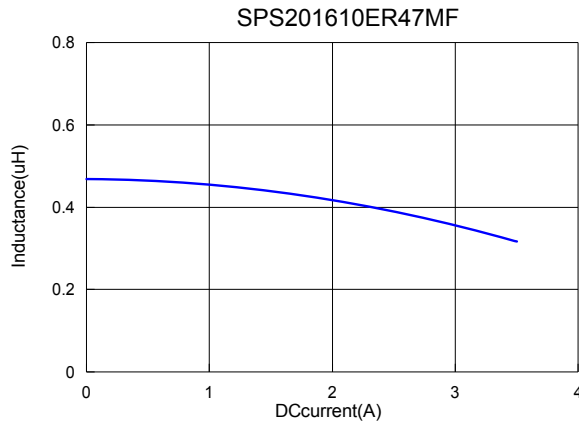

NOTE: Specifications subject to change without notice. Please check our website for latest information.



8. Soldering

Mildly activated rosin fluxes are preferred. The terminations are suitable for all wave and re-flow soldering systems. If hand soldering cannot be avoided, the preferred technique is the utilization of hot air soldering tools.

8-1 Solder Re-flow:

Recommended temperature profiles for re-flow soldering in Figure 1.

8-2 Soldering Iron (Figure 2):

Products attachment with soldering iron is discouraged due to the inherent process control limitations. In the event that a soldering iron must be employed the following precautions are recommended.

Note :

- a) Preheat circuit and products to 150°C.
- b) 355°C tip temperature (Max.)
- c) Never contact the ceramic with the iron tip
- d) 1.0mm tip diameter (Max.)
- e) Use a 20 watt soldering iron with tip diameter of 1.0mm
- f) Limit soldering time to 4~5 secs.

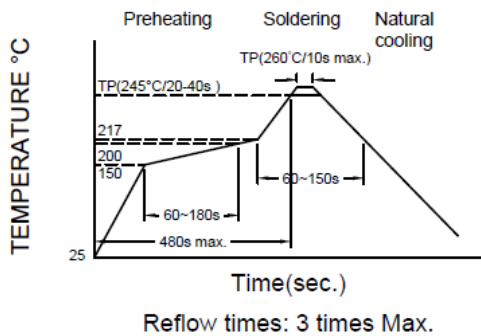

Fig.1

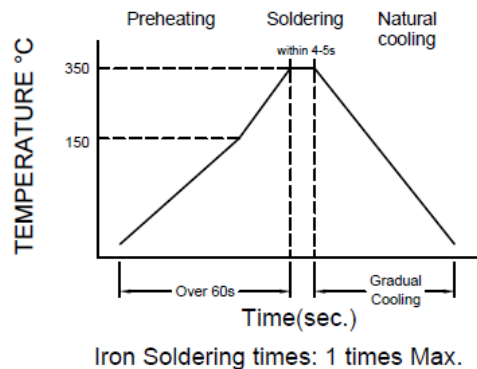

Fig.2

NOTE: Specifications subject to change without notice. Please check our website for latest information.



9. Packaging Information

9-1. Reel Dimension

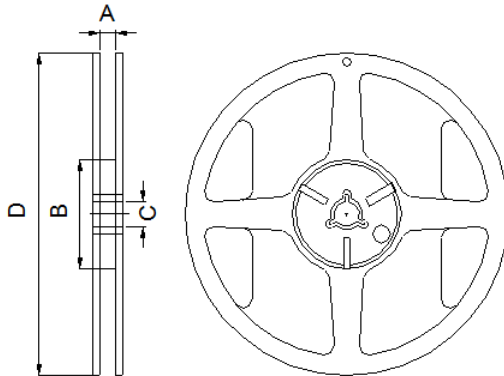

Type	A (mm)	B (mm)	C (mm)	D (mm)
7" x 8mm	8.4 ± 1.0	50 Min.	13.0 ± 0.8	178.0 ± 2.0

9-2. Tape Dimension

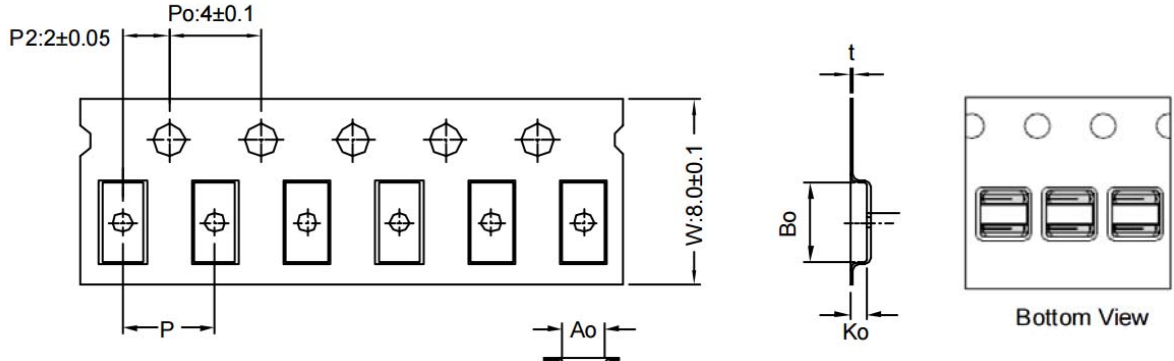

Series	Ao(mm)	Bo(mm)	Ko(mm)	P(mm)	t(mm)
SPS201610	2.00 ± 0.10	2.50 ± 0.10	1.40 ± 0.10	4.00 ± 0.10	0.23 ± 0.05

9-3. Packaging Quantity

Size	201610
Chip/ Reel	2000

NOTE: Specifications subject to change without notice. Please check our website for latest information.

9-4. Tearing Off Force

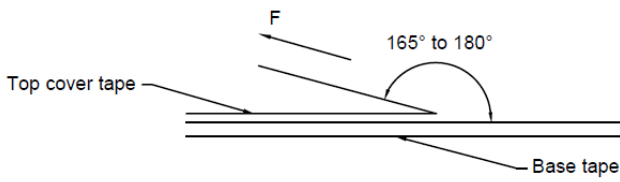

The force for tearing off cover tape is 15 to 80 grams in the arrow direction under the following conditions.

Room Temp (°C)	Room Humidity (%)	Room atm (hPa)	Tearing Speed (mm/min)
5 - 35	45 - 85	860 - 1060	300

Application Notice:

1. Storage Conditions:

To maintain the solderability of terminal electrodes:

- a) Recommended products should be used within 12 months from the time of delivery.
- b) The packaging material should be kept where no chlorine or sulfur exists in the air.

2. Transportation:

- a) Products should be handled with care to avoid damage or contamination from perspiration and skin oils.
- b) Vacuum pick up is strongly recommended for individual components.
- c) Bulk handling should ensure that abrasion and mechanical shock are minimized.

NOTE: Specifications subject to change without notice. Please check our website for latest information.

