

1. Part No. Expression:

Z 1 K 3 0 0 - R C - □ □  
 (a)(b)(c) (d) (e)(f) (g)

(a) Series code

(b) Dimension code

(c) Material code

(d) Impedance code : 300 = 30.0Ω

(e) R : Reel

(f) Current : C = 300mA

(g) 10: Standard

11 ~ 99 : Internal control number

2. Configuration & Dimensions:

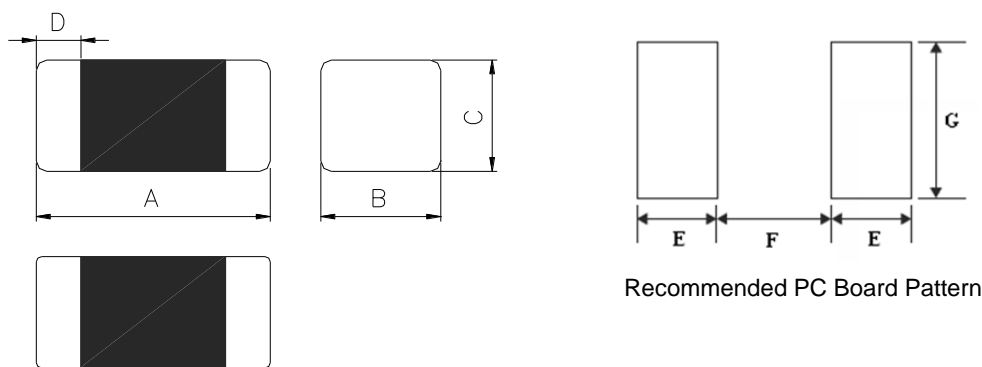

Unit: mm

A	B	C	D	E	F	G
1.00±0.10	0.50±0.10	0.50±0.10	0.25±0.10	0.50 Ref.	0.40 Ref.	0.60 Ref.

3. Schematic:

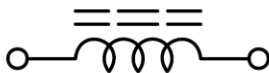

4. Material List:

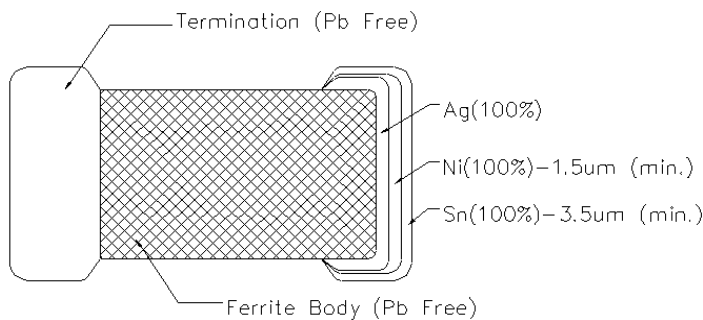

NOTE: Specifications subject to change without notice. Please check our website for latest information.

## 5. General Specification:

- (a) Operating Temp. : -55°C to +125°C (Including self - temperature rise).
- (b) Storage Temp. : -55°C to +125°C (on Board).
- (c) Temperature Rise. : 20°C Max. at Rated Current <1A
- (d) Storage Condition (Component in its packaging)
  - i) Temperature: Less than 40°C
  - ii) Humidity : 60% RH

## 6. Electrical Characteristics:

Part Number	Impedance (Ω)±25%	Test Frequency (MHz)	DCR (Ω) Max.	Rated Current (mA) Max.
Z1K300-RC-10	30	100	0.20	300
Z1K600-RC-10	60	100	0.25	300
Z1K121-RA-10	120	100	0.30	100
Z1K151-RA-10	150	100	0.30	100
Z1K221-RA-10	220	100	0.40	100
Z1K301-RA-10	300	100	0.50	100
Z1K471-RA-10	470	100	0.65	100
Z1K601-RA-10	600	100	0.80	80
Z1K102-RA-10	1000	100	1.20	50
Z1M600-RA-10	60	100	0.30	100
Z1M121-RA-10	120	100	0.45	80
Z1M221-RA-10	220	100	0.60	50
Z1M301-RA-10	300	100	0.75	50

NOTE: Specifications subject to change without notice. Please check our website for latest information.



7. Characteristics Curve:

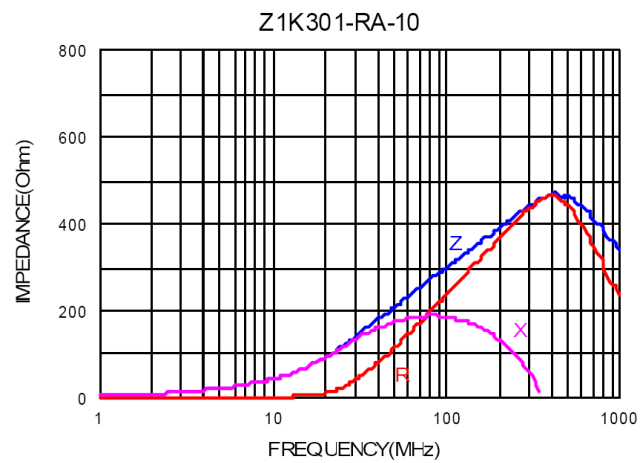
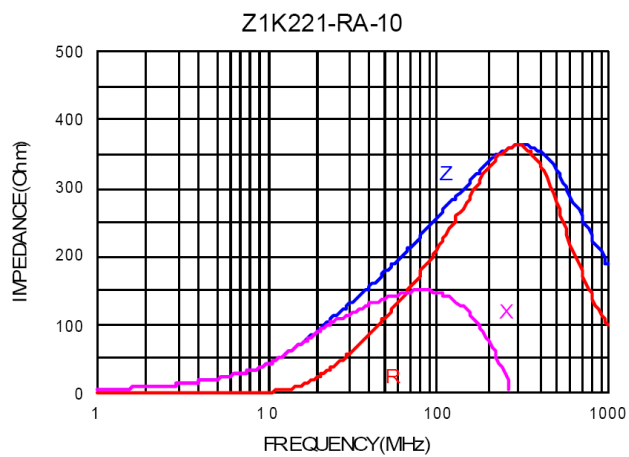
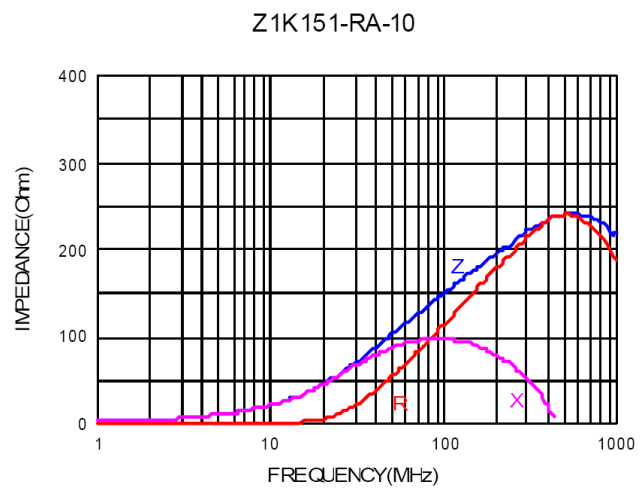
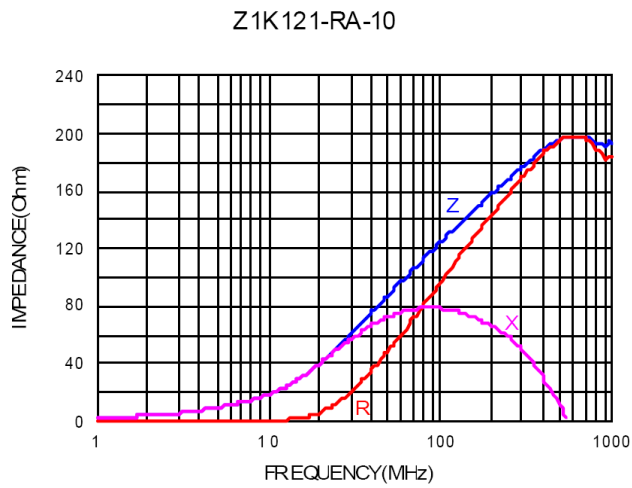
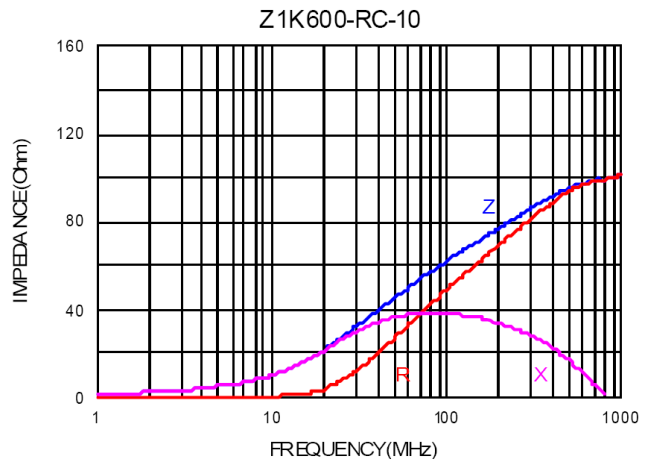
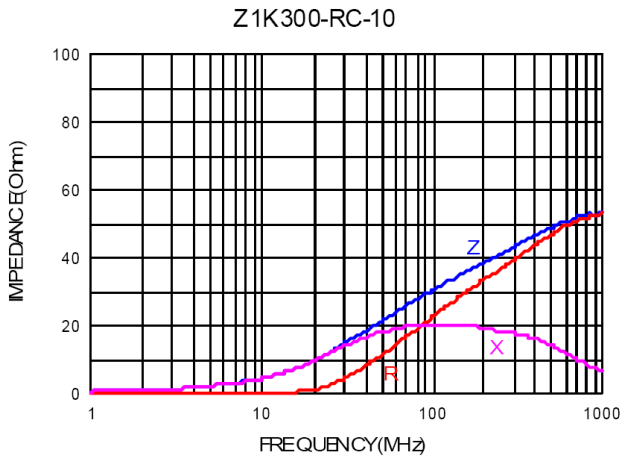

NOTE: Specifications subject to change without notice. Please check our website for latest information.



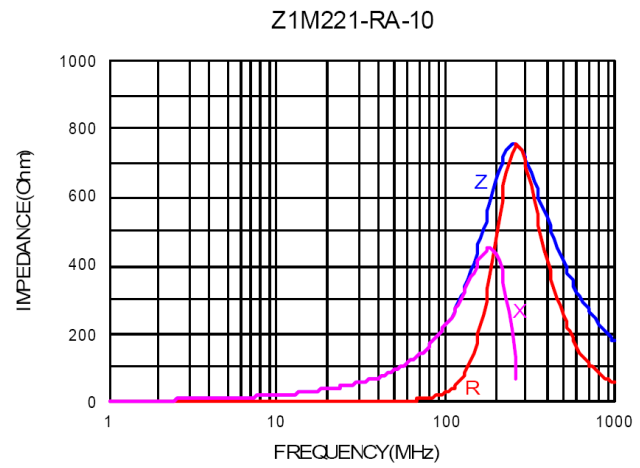
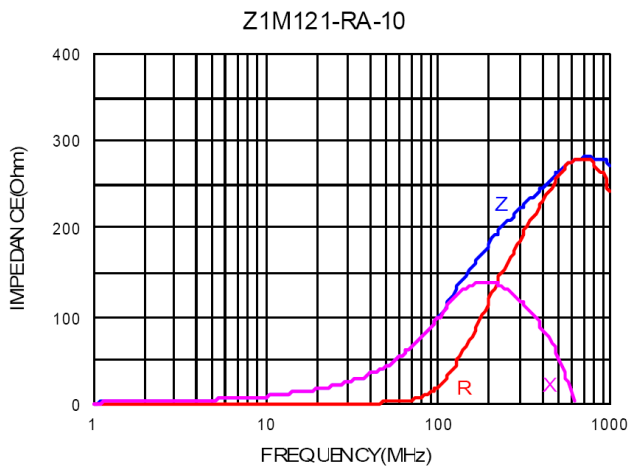
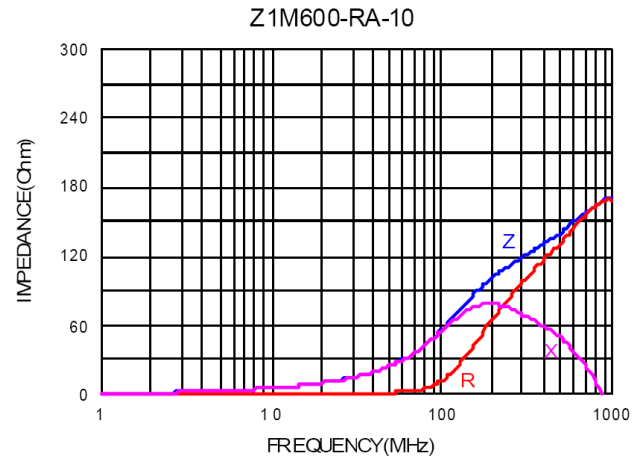
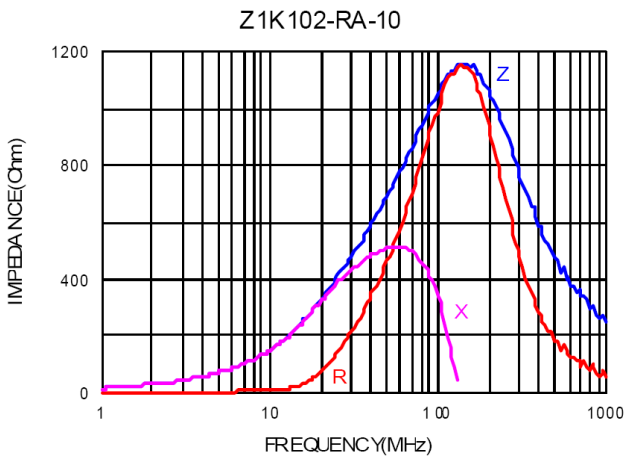
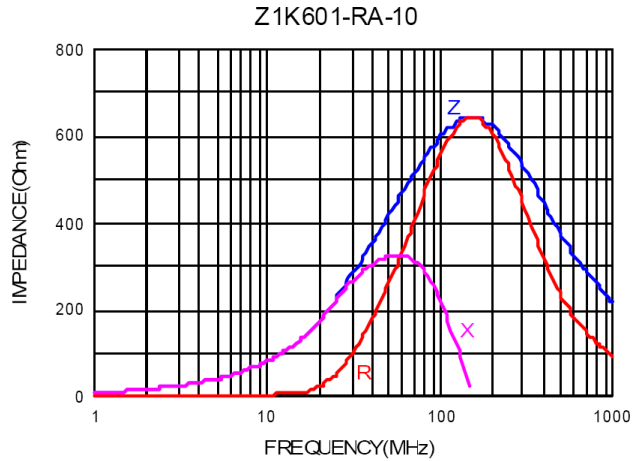
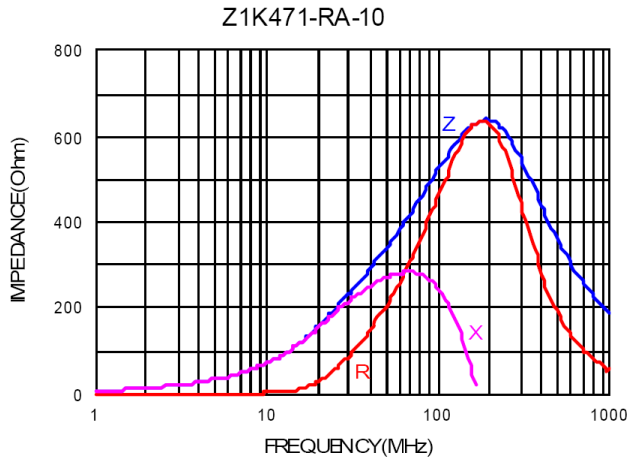

NOTE: Specifications subject to change without notice. Please check our website for latest information.



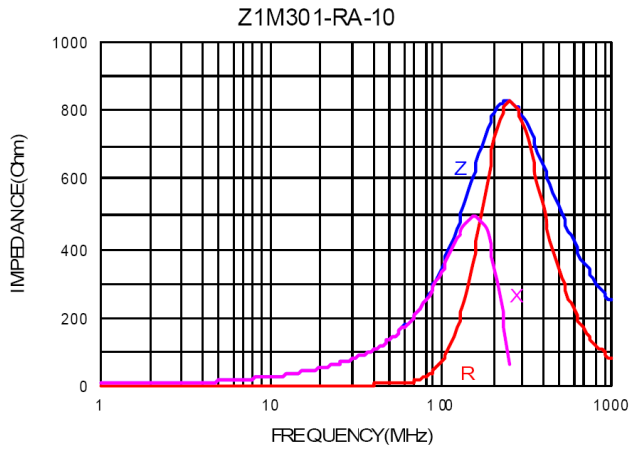

NOTE: Specifications subject to change without notice. Please check our website for latest information.



**8. Soldering:**

Mildly activated rosin fluxes are preferred. Our terminations are suitable for all re-flow soldering systems. If hand soldering cannot be avoided, the preferred technique is the utilization of hot air soldering tools.

Note:

If wave soldering is used, there will be some risk.

Re-flow soldering temperatures below 240 degrees, there will be non-wetting risk

**8-1 Solder Re-flow:**

Recommended temperature profiles for re-flow soldering in Figure 1.

**8-2 Soldering Iron (Figure 2):**

Products attachment with soldering iron is discouraged due to the inherent process control limitations. In the event that a soldering iron must be employed the following precautions are recommended.

Note :

- a) Preheat circuit and products to 150°C.
- b) 350°C tip temperature (max)
- c) Never contact the ceramic with the iron tip
- d) 1.0mm tip diameter (max)
- e) Use a 20 watt soldering iron with tip diameter of 1.0mm
- f) Limit soldering time to 4~5 sec.

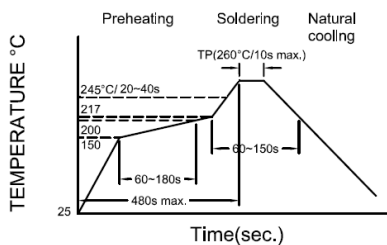

Figure 1. : Re-flow Soldering time 3 times Max.

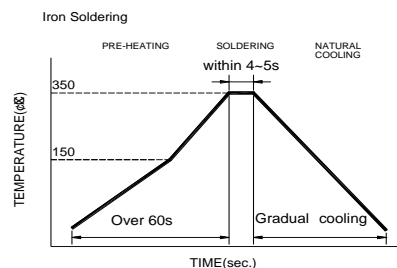
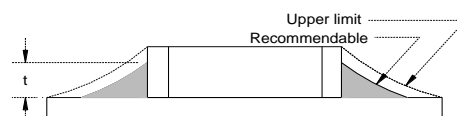

Figure 2. : Iron Soldering time 1 times Max.

**8-3 Soldering Volume:**

Accordingly increasing the solder volume, the mechanical stress to product is also increased. Exceeding solder volume may cause the failure or mechanical or electrical performance. Solder shall be used not to be exceeding as shown in the Figure below. Minimum fillet height = soldering thickness + 25% product height.



NOTE: Specifications subject to change without notice. Please check our website for latest information.



9. Packaging Information:

9-1 Reel Dimension

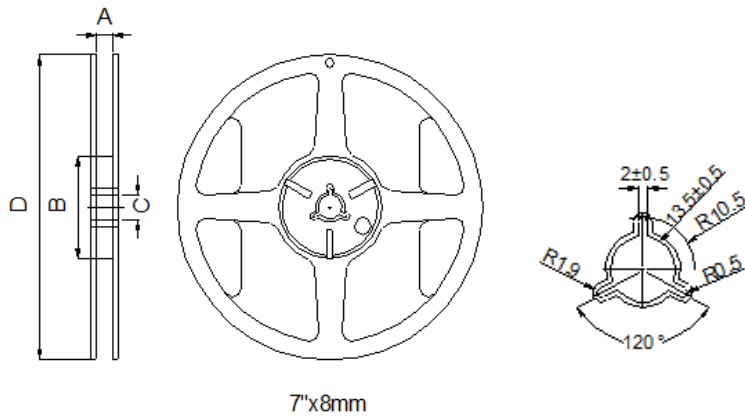

Type	A(mm)	B(mm)	C(mm)	D(mm)
7"×8mm	9.0±0.5	60±2	13.5±0.5	178±2

9-2 Tape Dimension

Material of taping is paper

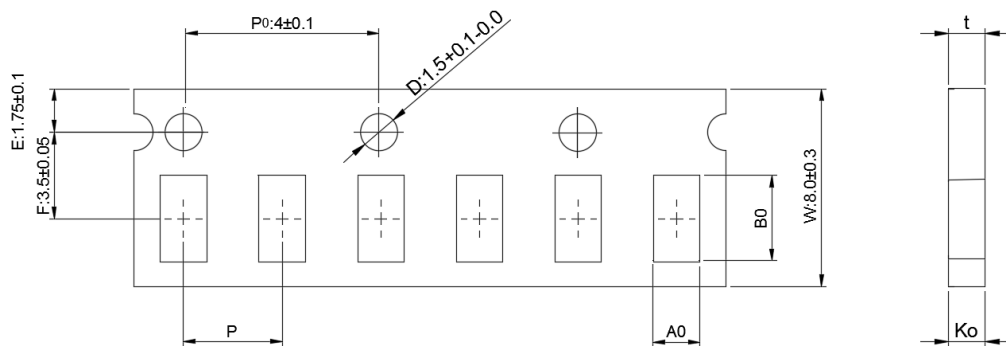

Size	Bo(mm)	Ao(mm)	Ko(mm)	P(mm)	t(mm)
Z1	1.12±0.03	0.62±0.03	0.60±0.03	2.0±0.05	0.60±0.03

NOTE: Specifications subject to change without notice. Please check our website for latest information.

### 9-3 Packaging Quantity

Chip Size	Z1
Chip/Reel	10000
Inner Box	50000
Middle Box	250000
Carton	500000

### 9-4 Tearing Off Force

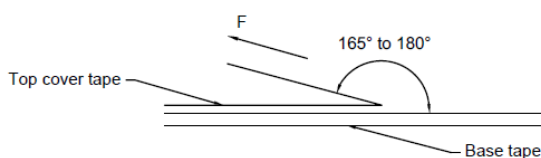

The force for tearing off cover tape is 15 to 60 grams in the arrow direction under the following conditions.

Room Temp. (°C)	Room Humidity (%)	Room atm (hPa)	Tearing Speed mm/min
5~35	45~85	860~1060	300

## Application Notice:

#### 1. Storage Conditions:

To maintain the solderability of terminal electrodes:

- a) Recommended products should be used within 12 months from the time of delivery.
- b) The packaging material should be kept where no chlorine or sulfur exists in the air.

#### 2. Transportation:

- a) Products should be handled with care to avoid damage or contamination from perspiration and skin oils.
- b) Vacuum pick up is strongly recommended for individual components.
- c) Bulk handling should ensure that abrasion and mechanical shock are minimized

NOTE: Specifications subject to change without notice. Please check our website for latest information.

