

1. Part No. Expression

P I M Q 3 2 2 5 2 0 A R 3 3 M N

(a) (b) (c) (d) (e) (f)

- (a) Series Code
- (b) Dimension Code
- (c) Material Code
- (d) Inductance Code
- (e) Tolerance Code
- (f) Special Code

2. Configuration & Dimensions (Unit: mm)

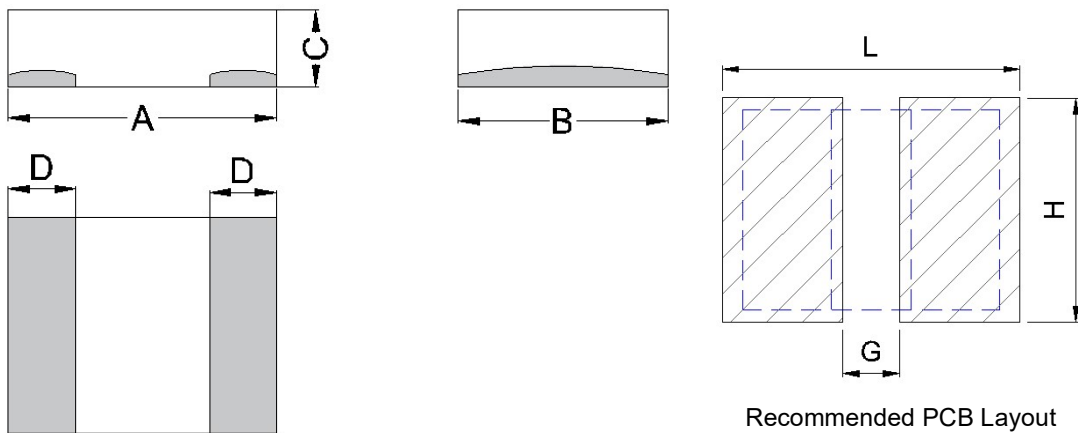

A(mm)	B(mm)	C(mm)	D(mm)	L(mm)	G(mm)	H(mm)
3.2±0.3	2.5±0.3	1.8±0.2	1.1±0.3	3.7 Ref	0.7 Ref	2.8 Ref

3. Schematic

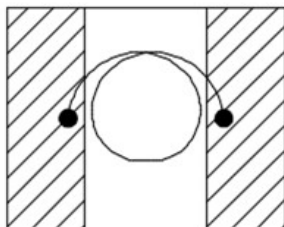

NOTE: Specifications subject to change without notice. Please check our website for latest information.

4. General Specification

- (a) Reliability test for this part meets AEC-Q200 standard.
- (b) Operating Temp.: -55°C to +150°C (including self-temperature rise)
- (c) Storage Temp.: -55°C to +150°C (on board)
- (d) All test data referenced to 25°C ambient.
- (e) Heat Rated Current (Irms) will cause the coil temperature rise approximately ΔT of 40°C.
- (f) Saturation Current (Isat) will cause inductance L0 to drop approximately 30%.
- (g) Rated Voltage 25V_{DC}. The application of voltage depends on many factors.
Over voltage may cause components failure, high temperature, and burn-out.
- (h) Rated DC current: The lower value of Irms and Isat.
- (i) Part Temperature (Ambient + Temp. Rise): Should not exceed 150°C under worst case operating conditions.
- (j) Storage Condition (Component in its packaging)
 - i) Temperature: Less than 40°C
 - ii) Humidity: Less than 60% RH

5. Electrical Characteristics

Part No.	Inductance @ 0A (μ H) $\pm 20\%$	Irms (A) Typ	Irms (A) Max	Isat (A) Typ	Isat (A) Max	DCR (m Ω) Typ	DCR (m Ω) Max
PIMQ322520AR33MN	0.33	8.5	8.0	11.0	10.0	8.0	9.6
PIMQ322520AR47MN	0.47	8.0	7.5	9.0	8.0	9.3	11.2
PIMQ322520AR68MN	0.68	7.0	6.4	8.0	7.0	13.3	16.0
PIMQ322520A1R0MN	1.00	6.2	5.8	7.5	6.2	18.3	22.0
PIMQ322520A1R5MN	1.50	5.3	4.8	6.0	5.0	25.8	31.0
PIMQ322520A2R2MN	2.20	3.7	3.2	5.0	4.5	38.0	46.0
PIMQ322520A3R3MN	3.30	3.2	2.7	4.2	3.7	56.0	65.0
PIMQ322520A4R7MN	4.70	2.8	2.4	3.4	2.9	90.0	98.0

Test Frequency: 1.0V/100kHz

NOTE: Specifications subject to change without notice. Please check our website for latest information.



6. Characteristics Curve

PIMQ322520AR33MN

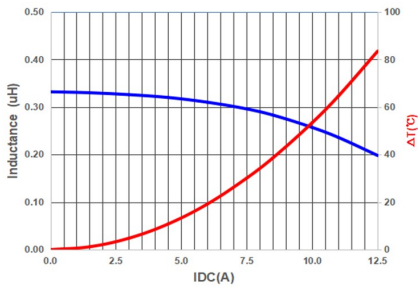

PIMQ322520AR47MN

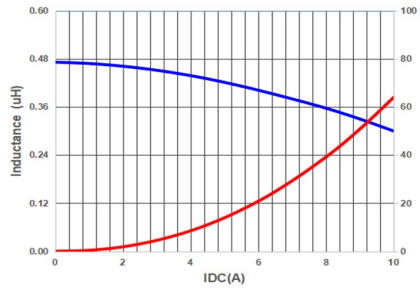

PIMQ322520AR68MN

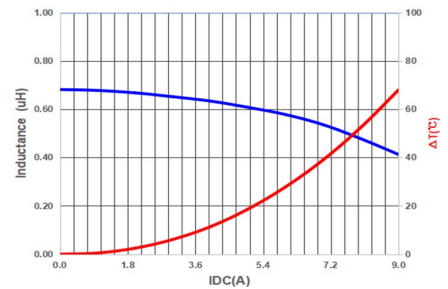

PIMQ322520A1R0MN

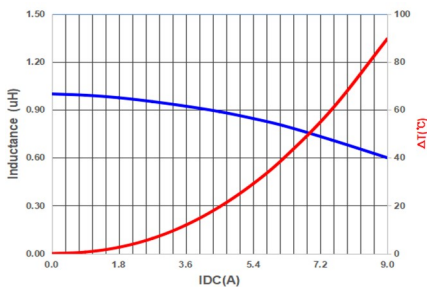

PIMQ322520A1R5MN

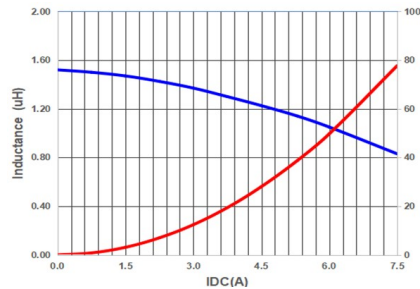

PIMQ322520A2R2MN

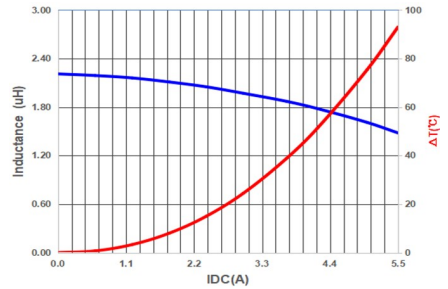

PIMQ322520A3R3MN

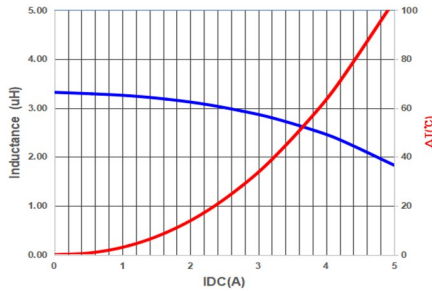

PIMQ322520A4R7MN

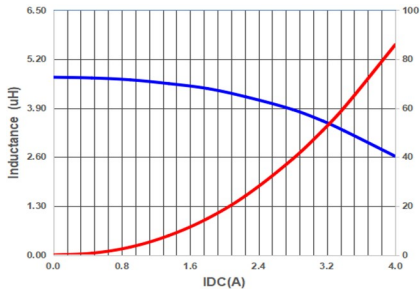

NOTE: Specifications subject to change without notice. Please check our website for latest information.



7. Soldering Specification

Mildly activated rosin fluxes are preferred. Our terminations are suitable for re-flow soldering systems. If hand soldering cannot be avoided, the preferred technique is the utilization of hot air soldering tools.

7-1. IR Soldering Reflow

Recommended temperature profiles for lead free re-flow soldering in Figure 1, Table 1.1 & 1.2 (J-STD-020E).

7-2. Iron Reflow

Products attachment with a soldering iron is discouraged due to the inherent process control limitations. In the event that a soldering iron must be employed the following precautions are recommended (Figure 2).

Note:

- (a) Preheat circuit and products to 150°C.
- (b) 355°C tip temperature (Max.)
- (c) Never contact the ceramic with the iron tip
- (d) 1.0mm tip diameter (Max.)
- (e) Use a 20 watt soldering iron with tip diameter of 1.0mm
- (f) Limit soldering time to 4~5 sec.

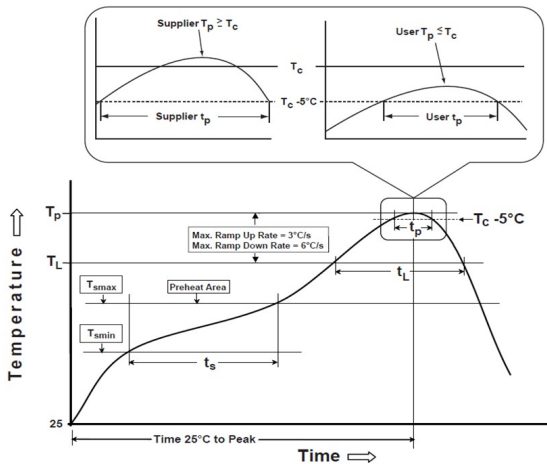

Reflow times: 3 times Max

Figure 1: IR Soldering Reflow

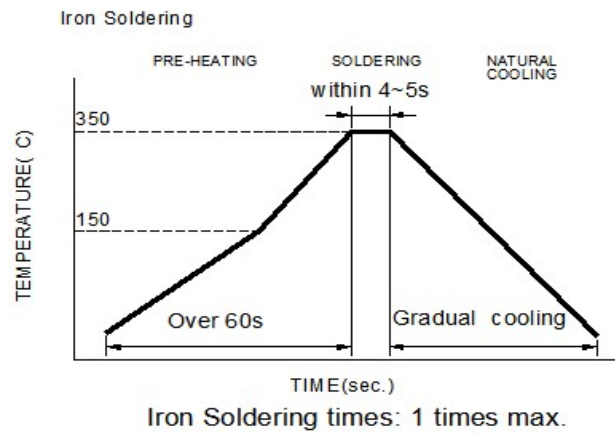

Soldering iron method: 350±5°C Max

Figure 2: Iron soldering temperature profiles

NOTE: Specifications subject to change without notice. Please check our website for latest information.



Table (1.1) Reflow Profiles

Profile Type:	Pb-Free Assembly
Preheat	
-Temperature Min (T_{smin})	150°C
-Temperature Max (T_{smax})	200°C
-Time (t_s) from (T_{smin} to T_{smax})	60-120seconds
Ramp-up rate (T_L to T_p)	3°C /second max.
Liquids temperature (T_L)	217°C
Time (t_L) maintained above T_L	60-150 seconds
Classification temperature (T_c)	See Table (1.2)
Time (t_p) at $T_c - 5^\circ\text{C}$ (T_p should be equal to or less than T_c .)	* < 30 seconds
Ramp-down rate (T_p to T_L)	6°C /second max.
Time 25°C to peak temperature	8 minutes max.

T_p: maximum peak package body temperature, **T_c**: the classification temperature.

For user (customer) **T_p** should be equal to or less than **T_c**.

*Tolerance for peak profile temperature (T_p) is defined as a supplier minimum and a user maximum.

Table (1.2) Package Thickness/Volume and Classification Temperature (T_c)

	Package Thickness	Volume mm ³ <350	Volume mm ³ 350-2000	Volume mm ³ >2000
PB-Free Assembly	<1.6mm	260°C	260°C	260°C
	1.6-2.5mm	260°C	250°C	245°C
	≥2.5mm	250°C	245°C	245°C

Reflow is referred to standard IPC/JEDEC J-STD-020E.

NOTE: Specifications subject to change without notice. Please check our website for latest information.

8. Packaging Information

8-1. Reel Dimension (Unit: mm)

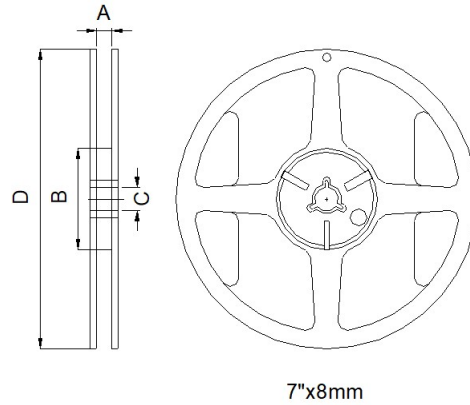

Type	A	B	C	D
7"x8mm	8.4+1.5/-0.0	50.0 Min	13.0+5.5/-0.2	178.0±2.0

8-2. Tape Dimension (Unit: mm)

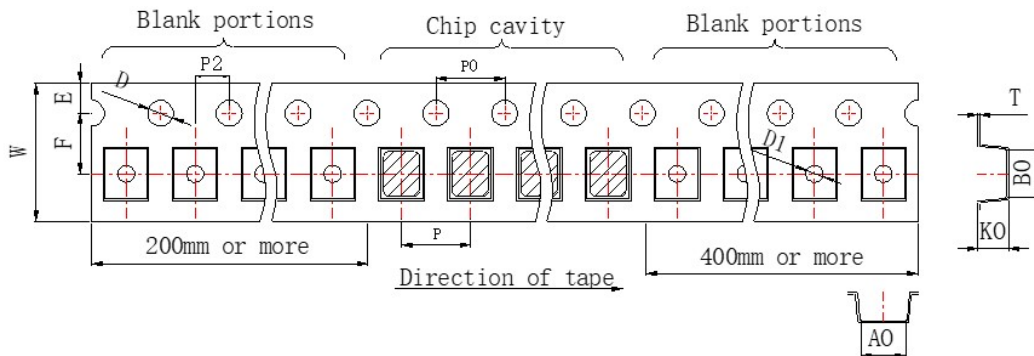

Bo	Ao	Ko	W	P	P0
3.60±0.10	2.90±0.10	2.20±0.10	8.00±0.10	4.00±0.10	4.00±0.10
P2	E	F	T	D	D1
2.00±0.10	1.75±0.10	3.50±0.10	0.22±0.05	1.50+0.10/-0.00	1.50+0.10/-0.00

NOTE: Specifications subject to change without notice. Please check our website for latest information.



8-3. Packaging Quantity

Chip/ Reel	2,000
------------	-------

8-4. Tearing Off Force

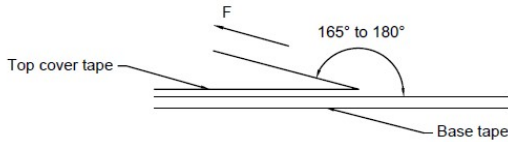

The force for tearing off cover tape is according to the follow table, in the arrow direction under the following conditions.

(Referenced ANSI/EIA-481-D-2008 of 4.11 standard)

Room Temp. (°C)	Room Humidity (%)	Room atm (hPa)	Tearing Speed (mm/min)
5~35	45~85	860~1060	300±10

Tape Size	8 mm	12 to 56 mm	72 mm or Wider
Tearing Off Force (grams)	10~100	10~130	10~150

Application Notice

1. Storage Conditions

To maintain the solderability of terminal electrodes:

- (a) Recommended products should be used within 12 months from the time of delivery.
- (b) The packaging material should be kept where no chlorine or sulfur exists in the air.

2. Transportation

- (a) Products should be handled with care to avoid damage or contamination from perspiration and skin oils.
- (b) Vacuum pick up is strongly recommended for individual components.
- (c) Bulk handling should ensure that abrasion and mechanical shock are minimized.

NOTE: Specifications subject to change without notice. Please check our website for latest information.

