

## 1. Part No. Expression

**Z Q 3 K 3 0 0 - R N - 1 0**

(a) (b) (c) (d) (e) (f) (g)

- |                    |                    |
|--------------------|--------------------|
| (a) Series Code    | (e) Packaging Code |
| (b) Dimension Code | (f) Current Code   |
| (c) Material Code  | (g) Internal Code  |
| (d) Impedance Code |                    |

## 2. Configuration & Dimensions (Unit: mm)

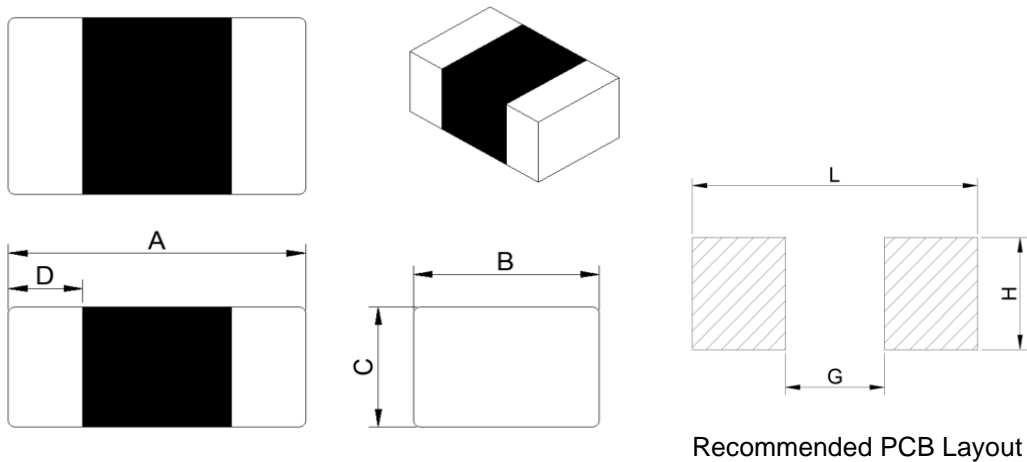

A	B	C	D	L	G	H
2.00±0.20	1.25±0.20	0.85±0.20	0.50±0.30	3.10 Ref	1.00 Ref	1.45 Ref

**NOTE:** Specifications subject to change without notice. Please check our website for latest information.

## 3. General Specifications

- (a) Reliability test for this part meets AEC-Q200 standard.
- (b) Operating Temp.: -55°C to +150°C (including self-temperature rise)
- (c) Storage Temp.: -55°C to +150°C (on board)
- (d) Irms: Based on temperature rise  $\Delta T$  20°C Max at rated current < 1A and  $\Delta T$  40°C Max at rated current  $\geq 1A$
- (e) Storage Condition (Component in its packaging)
  - i) Temperature: Less than 40°C
  - ii) Humidity: Less than 60% RH

## 4. Electrical Characteristics

Part Number	Impedance ( $\Omega$ ) $\pm 25\%$	Test Frequency (MHz)	DCR ( $\Omega$ ) Max	Rated Current (mA) Max
ZQ3K300-RN-10	30	100	0.04	3000
ZQ3K800-RN-10	80	100	0.04	3000
ZQ3K121-RL-10	120	100	0.10	2000
ZQ3K151-RL-10	150	100	0.10	2000
ZQ3K221-RL-10	220	100	0.10	2000
ZQ3K301-RJ-10	300	100	0.20	1000
ZQ3K471-RJ-10	470	100	0.20	1000
ZQ3K601-RJ-10	600	100	0.20	1000

NOTE: Specifications subject to change without notice. Please check our website for latest information.

## 5. Characteristics Curve

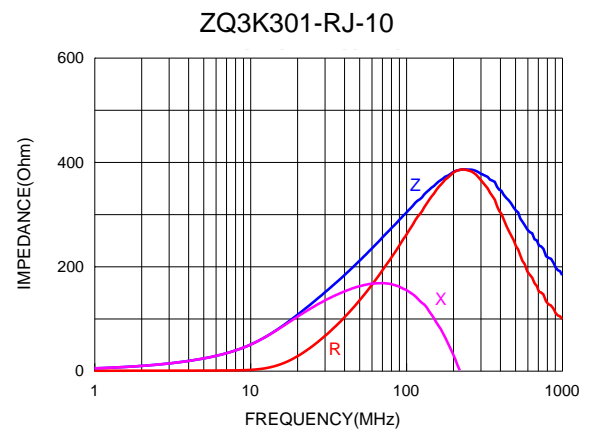
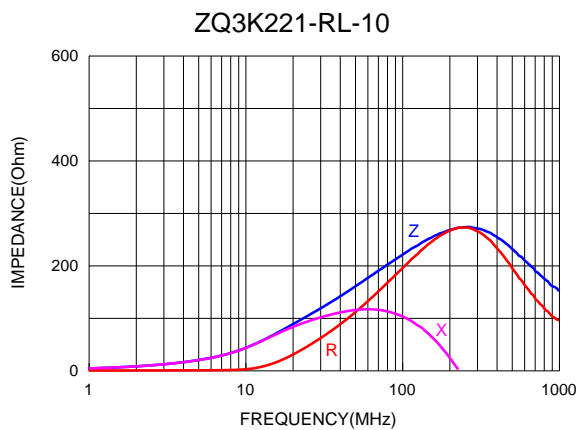
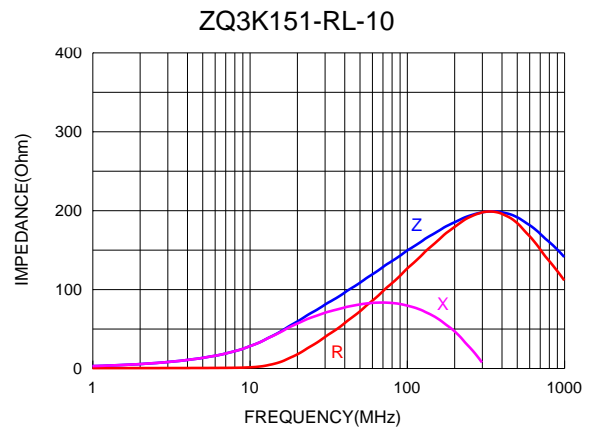
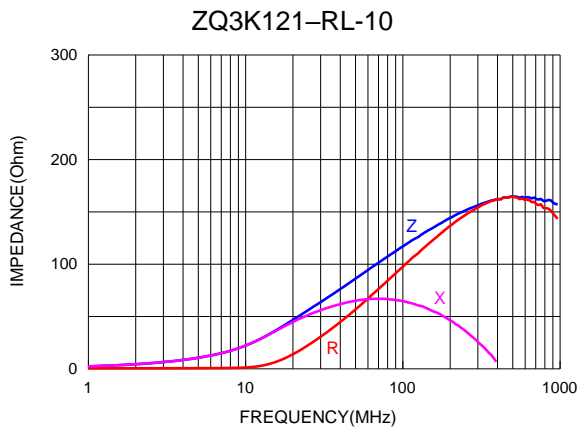
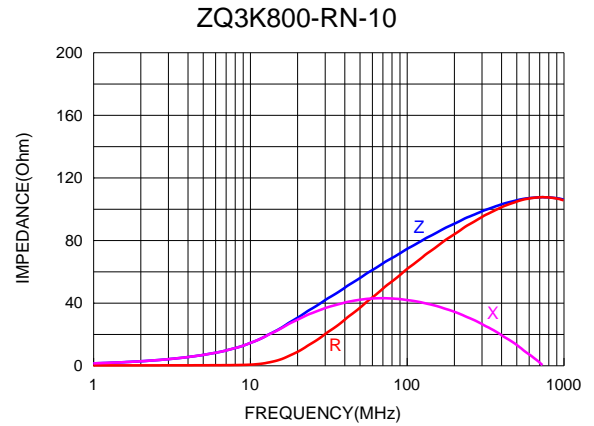
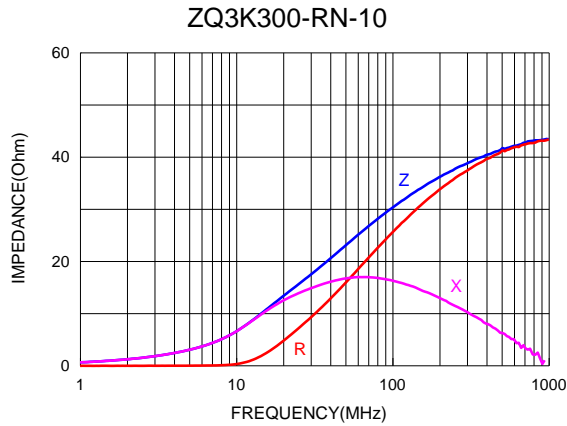

NOTE: Specifications subject to change without notice. Please check our website for latest information.

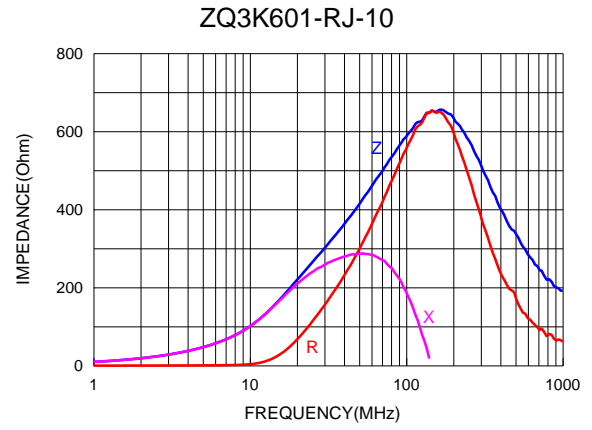
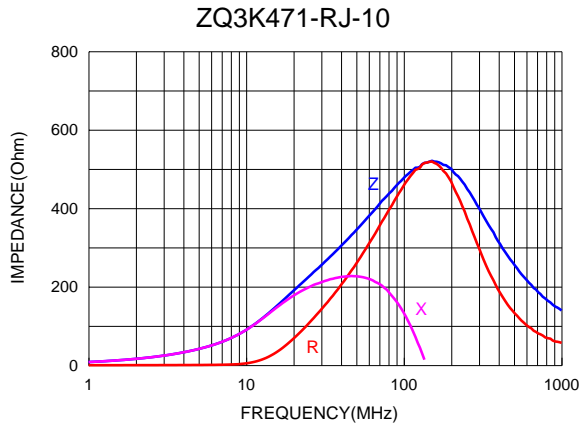

NOTE: Specifications subject to change without notice. Please check our website for latest information.

## 6. Soldering Specification

Mildly activated rosin fluxes are preferred. Our terminations are suitable for re-flow soldering systems. If hand soldering cannot be avoided, the preferred technique is the utilization of hot air soldering tools.

### 6-1. IR Soldering Reflow

Recommended temperature profiles for lead free re-flow soldering in Figure 1, Table 1.1 & 1.2 (J-STD-020E).

### 6-2. Iron Reflow

Products attachment with a soldering iron is discouraged due to the inherent process control limitations. In the event that a soldering iron must be employed the following precautions are recommended (Figure 2).

Note:

- (a) Preheat circuit and products to 150°C.
- (b) 355°C tip temperature (Max.)
- (c) Never contact the ceramic with the iron tip
- (d) 1.0mm tip diameter (Max.)
- (e) Use a 20 watt soldering iron with tip diameter of 1.0mm
- (f) Limit soldering time to 4~5 sec.

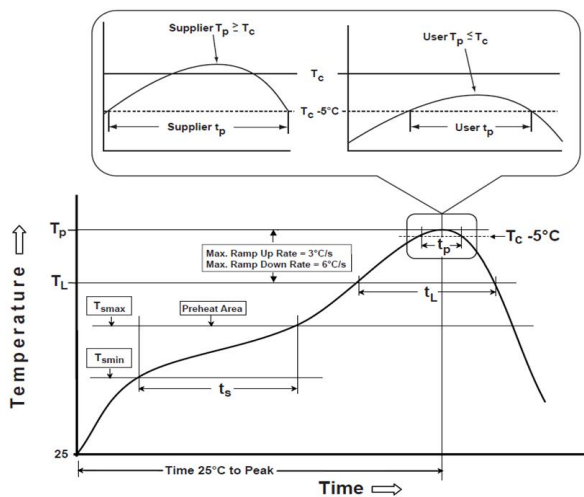

Reflow times: 3 times Max

Figure 1: IR Soldering Reflow

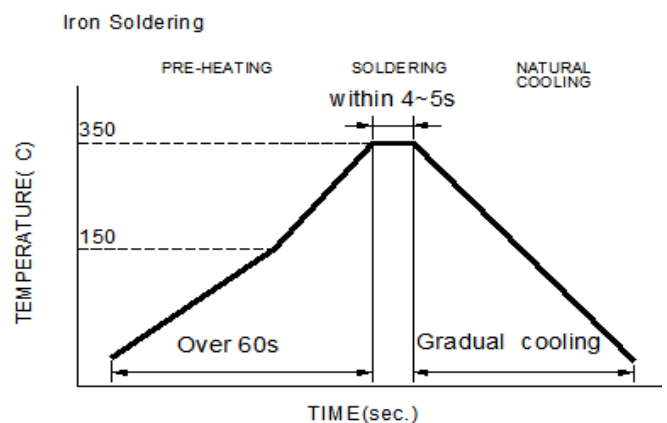

Iron Soldering times: 1 times max.

Soldering iron method: 350±5°C Max

Figure 2: Iron soldering temperature profiles

NOTE: Specifications subject to change without notice. Please check our website for latest information.

**Table (1.1) Reflow Profiles**

Profile Type:	Pb-Free Assembly
Preheat	
-Temperature Min ( $T_{smin}$ )	150°C
-Temperature Max ( $T_{smax}$ )	200°C
-Time ( $t_s$ ) from ( $T_{smin}$ to $T_{smax}$ )	60-120seconds
Ramp-up rate ( $T_L$ to $T_p$ )	3°C /second max.
Liquids temperature ( $T_L$ )	217°C
Time ( $t_L$ ) maintained above $T_L$	60-150 seconds
Classification temperature ( $T_c$ )	See Table (1.2)
Time ( $t_p$ ) at $T_c - 5^\circ\text{C}$ ( $T_p$ should be equal to or less than $T_c$ .)	* < 30 seconds
Ramp-down rate ( $T_p$ to $T_L$ )	6°C /second max.
Time 25°C to peak temperature	8 minutes max.

**T<sub>p</sub>**: maximum peak package body temperature, **T<sub>c</sub>**: the classification temperature.

For user (customer) **T<sub>p</sub>** should be equal to or less than **T<sub>c</sub>**.

\*Tolerance for peak profile temperature ( $T_p$ ) is defined as a supplier minimum and a user maximum.

**Table (1.2) Package Thickness/Volume and Classification Temperature ( $T_c$ )**

	Package Thickness	Volume mm <sup>3</sup> <350	Volume mm <sup>3</sup> 350-2000	Volume mm <sup>3</sup> >2000
PB-Free Assembly	<1.6mm	260°C	260°C	260°C
	1.6-2.5mm	260°C	250°C	245°C
	≥2.5mm	250°C	245°C	245°C

Reflow is referred to standard IPC/JEDEC J-STD-020E.

NOTE: Specifications subject to change without notice. Please check our website for latest information.

## 7. Packaging Information

### 7-1. Reel Dimension (Unit: mm)

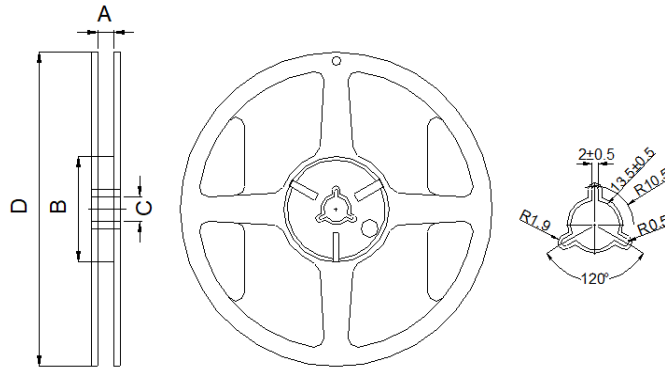

Type	A	B	C	D
7"x8mm	9.0±0.5	60.0±2.0	13.5±0.5	178.0±2.0

### 7-2. Tape Dimension (Unit: mm)

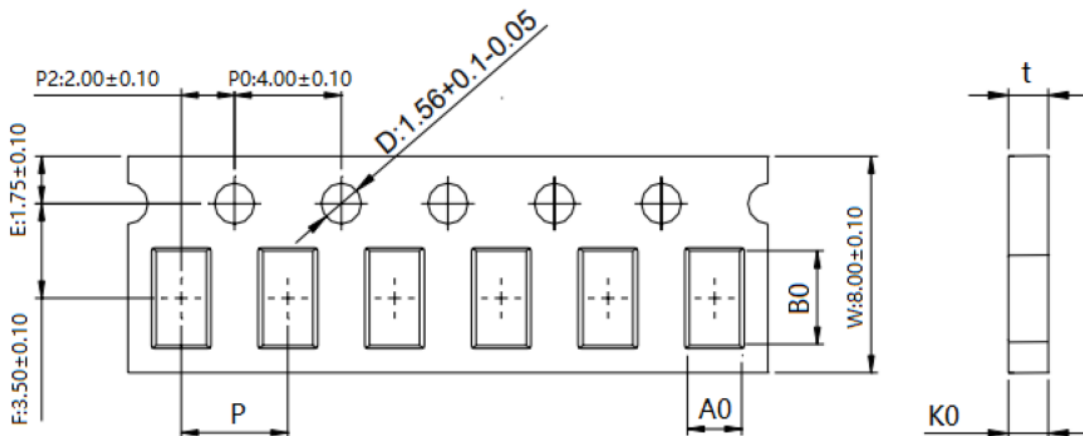

B0	A0	K0	P	t
2.10±0.05	1.30±0.05	0.95±0.05	4.00±0.10	0.95±0.05

NOTE: Specifications subject to change without notice. Please check our website for latest information.

### 7-3. Packaging Quantity (Unit: Pcs)

Chip/ Reel	4,000
Inner Box	20,000
Middle Box	100,000
Carton	200,000

### 7-4. Tearing Off Force

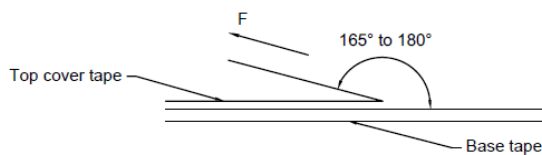

The force for tearing off cover tape is according to the follow table, in the arrow direction under the following conditions.

(Referenced ANSI/EIA-481-D-2008 of 4.11 standard)

Room Temp. (°C)	Room Humidity (%)	Room atm (hPa)	Tearing Speed (mm/min)
5~35	45~85	860~1060	300±10

Tape Size	8 mm	12 to 56 mm	72 mm or Wider
Tearing Off Force (grams)	10~100	10~130	10~150

## Application Notice

#### 1. Storage Conditions

To maintain the solderability of terminal electrodes:

- (a) Recommended products should be used within 12 months from the time of delivery.
- (b) The packaging material should be kept where no chlorine or sulfur exists in the air.

#### 2. Transportation

- (a) Products should be handled with care to avoid damage or contamination from perspiration and skin oils.
- (b) Vacuum pick up is strongly recommended for individual components.
- (c) Bulk handling should ensure that abrasion and mechanical shock are minimized.

NOTE: Specifications subject to change without notice. Please check our website for latest information.