

1. Part No. Expression

PIAQ1205SPR47MN

(a) (b) (c) (d) (e) (f)

- | | |
|--------------------|---------------------|
| (a) Series Code | (d) Inductance Code |
| (b) Dimension Code | (e) Tolerance Code |
| (c) Material Code | (f) Special Code |

2. Configuration & Dimensions (Unit: mm)

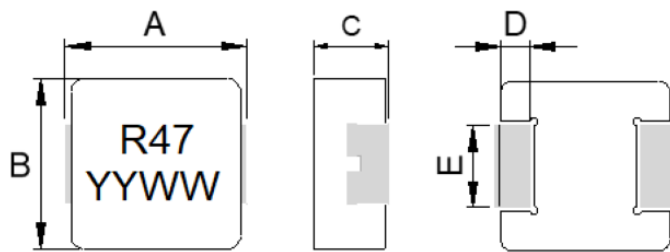

leadframe

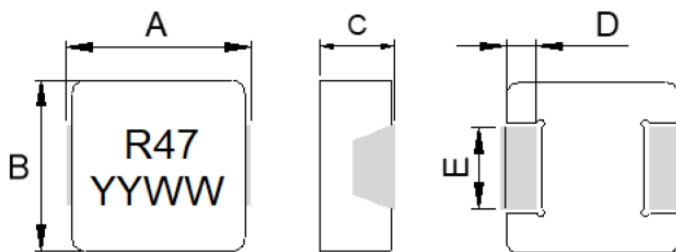

non-leadframe

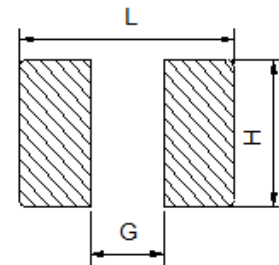

Recommended PCB Layout

- Note:
1. The above PCB layout reference only.
 2. Recommend solder paste thickness at 0.15 mm and above.
 3. Marking: Top= Inductance Code, Bottom=YYWWV (Year/World week), Black

Inductance	A	B	C	D	E	L	G	H
1.0uH and below	13.5±0.5	12.6±0.2	4.7±0.3	2.3±0.3	4.0±0.3	14.5 Ref	8.0 Ref	5.0 Ref
1.2uH and above					4.7±0.3			

NOTE: Specifications subject to change without notice. Please check our website for latest information.

3. Schematic

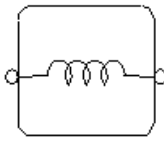

4. Material List

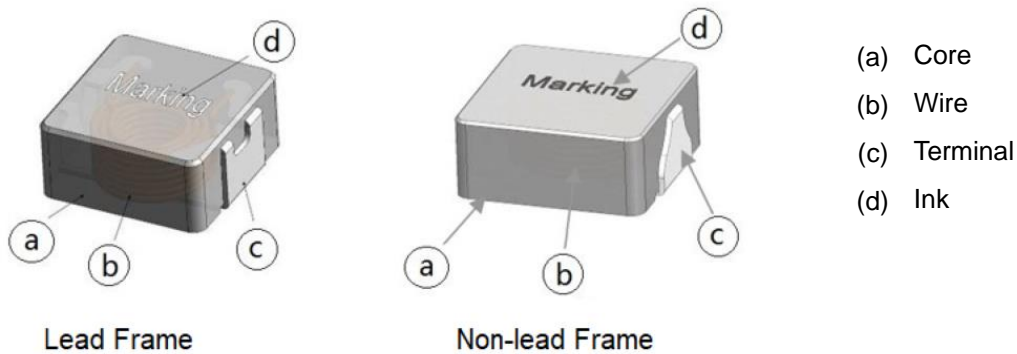

5. General Specifications

- (a) Reliability test for this part meets AEC-Q200 standard.
- (b) Operating Temp.: -55°C to +155°C (including self-temperature rise)
- (c) Storage Temp.: -55°C to +155°C (on board)
- (d) All test data referenced to 25°C ambient.
- (e) Heat Rated Current (I_{rms}) will cause the coil temperature rise approximately ΔT of 40°C.
- (f) Saturation Current (I_{sat}) will cause inductance L₀ to drop approximately 30%.
- (g) Rated Current: The lower value of I_{sat} and I_{rms}.
- (h) Part Temperature (Ambient + Temp. Rise): Should not exceed 155°C under worst case operating conditions.
- (i) Maximum Operating Voltage: 80V
- (j) Storage Condition (Component in its packaging)
 - i) Temperature: Less than 40°C
 - ii) Humidity: Less than 60% RH

NOTE: Specifications subject to change without notice. Please check our website for latest information.

6. Electrical Characteristics

Part Number	Inductance Lo (uH) @ 0A ±20%	I _{rms} (A)		I _{sat} (A)		DCR (mΩ)		Type
		Typ	Max	Typ	Max	Typ	Max	
PIAQ1205SPR47MN	0.47	38.0	34.0	65.0	58.0	0.77	0.90	Non lead frame
PIAQ1205SPR56MN	0.56	36.0	32.5	57.0	50.0	1.10	1.30	Non lead frame
PIAQ1205SPR68MN	0.68	34.0	31.0	50.0	42.0	1.30	1.55	Non lead frame
PIAQ1205SPR82MN	0.82	32.0	29.0	44.0	38.0	1.40	1.70	Non lead frame
PIAQ1205SP1R0MN	1.00	30.0	27.0	40.0	34.0	1.60	1.90	Non lead frame
PIAQ1205SP1R2MN	1.20	27.0	24.0	34.0	30.0	2.40	2.80	Lead frame
PIAQ1205SP1R5MN	1.50	25.0	22.0	31.0	28.0	3.20	3.80	Lead frame
PIAQ1205SP1R8MN	1.80	22.0	19.0	28.0	25.0	3.70	4.30	Lead frame
PIAQ1205SP2R2MN	2.20	17.0	15.5	26.0	23.0	4.10	4.80	Lead frame
PIAQ1205SP3R3MN	3.30	15.5	14.0	23.0	20.5	6.00	7.00	Lead frame
PIAQ1205SP4R7MN	4.70	14.0	12.5	18.5	16.0	8.80	10.2	Lead frame
PIAQ1205SP5R6MN	5.60	13.0	12.0	17.5	15.5	10.0	12.0	Lead frame
PIAQ1205SP6R8MN	6.80	12.0	11.0	16.5	15.0	13.0	16.0	Lead frame
PIAQ1205SP8R2MN	8.20	11.0	10.0	13.5	12.0	15.0	18.0	Lead frame
PIAQ1205SP100MN	10.0	10.0	9.00	13.0	10.5	19.2	22.0	Lead frame
PIAQ1205SP150MN	15.0	9.40	8.20	11.0	9.20	30.0	36.0	Lead frame
PIAQ1205SP220MN	22.0	8.00	7.00	8.50	7.50	42.0	52.0	Lead frame
PIAQ1205SP330MN	33.0	6.00	5.20	7.30	6.50	66.0	80.0	Lead frame

Note:

Test Frequency: 1.0V/100KHz

NOTE: Specifications subject to change without notice. Please check our website for latest information.

7. Characteristics Curve

PIAQ1205SPR47MN

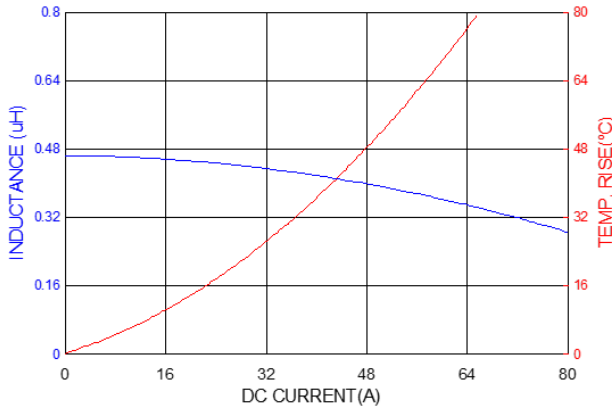

PIAQ1205SPR56MN

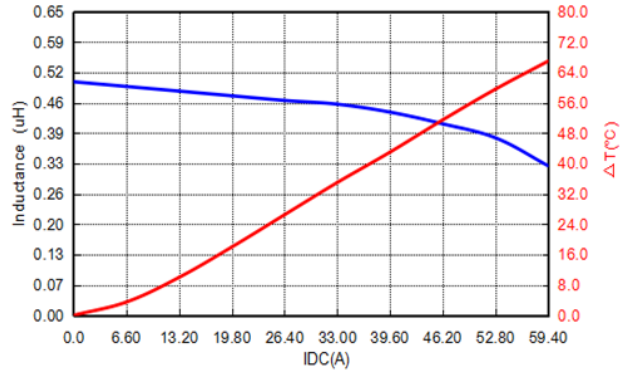

PIAQ1205SPR68MN

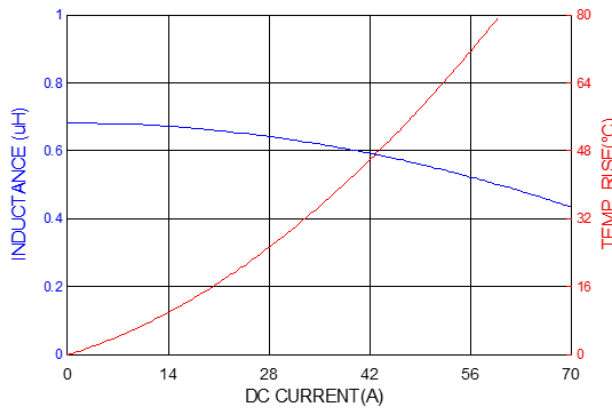

PIAQ1205SPR82MN

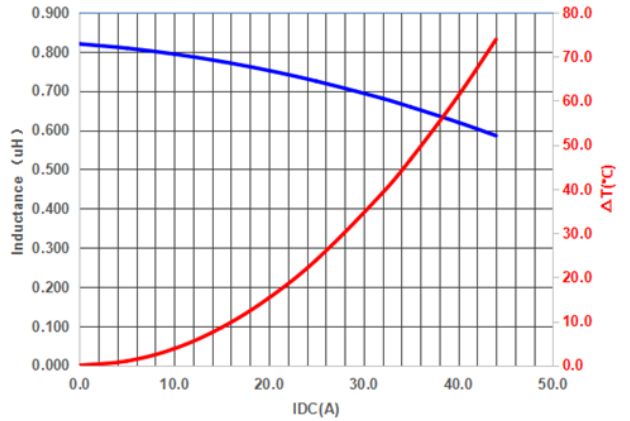

PIAQ1205SP1R0MN

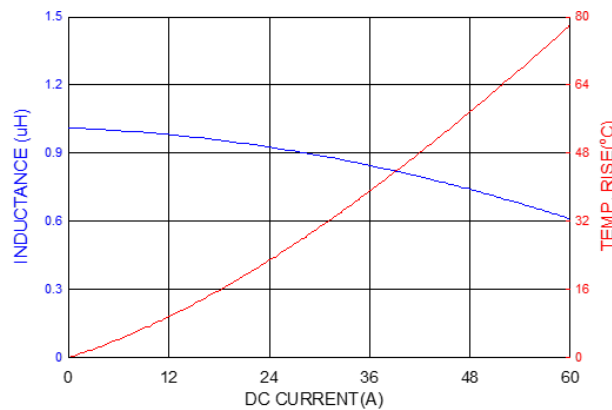

PIAQ1205SP1R2MN

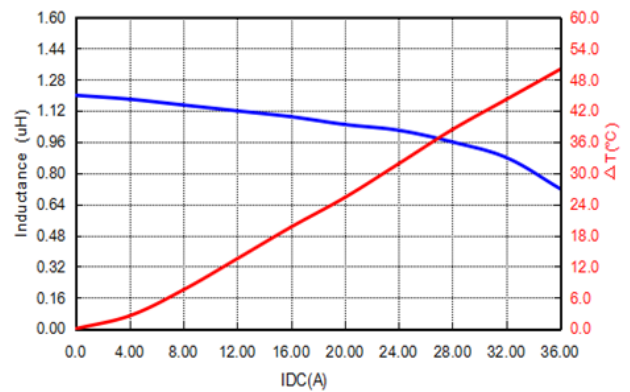

NOTE: Specifications subject to change without notice. Please check our website for latest information.

PIAQ1205SP1R5MN

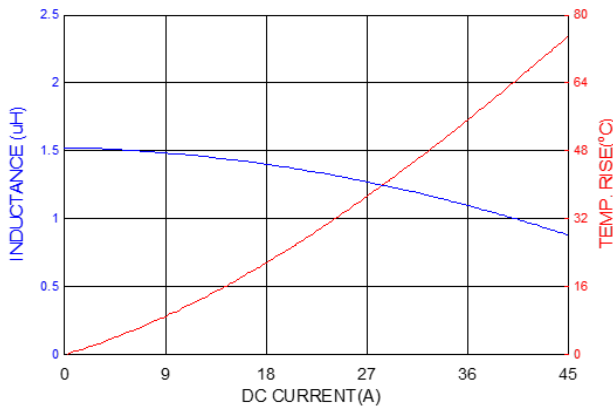

PIAQ1205SP1R8MN

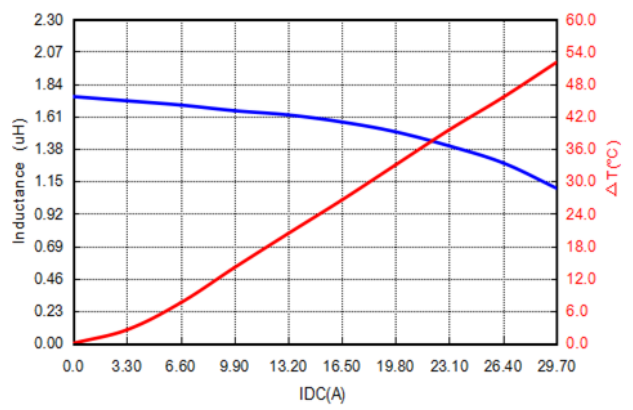

PIAQ1205SP2R2MN

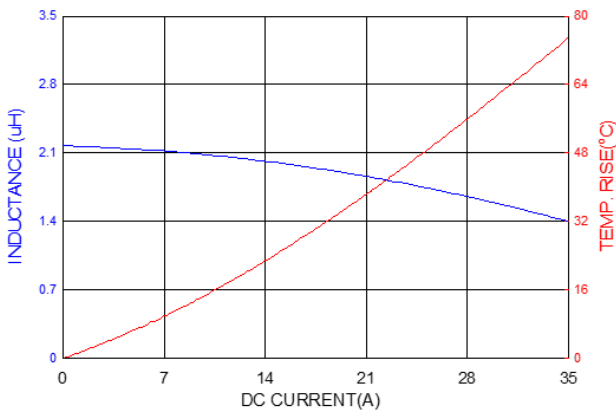

PIAQ1205SP3R3MN

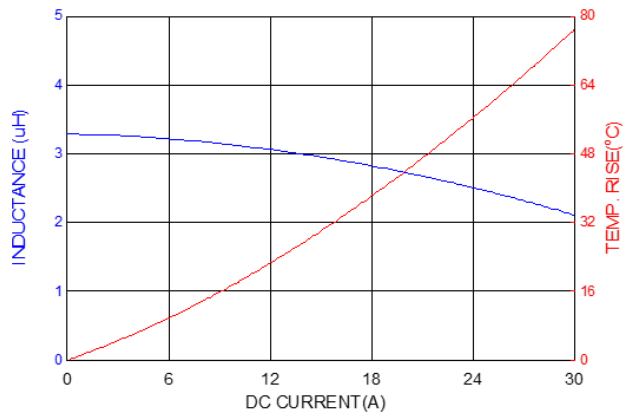

PIAQ1205SP4R7MN

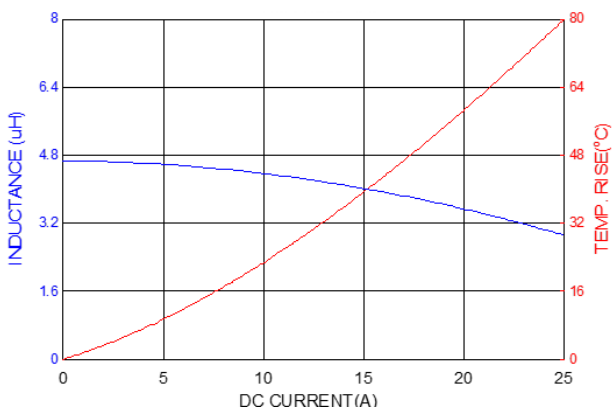

PIAQ1205SP5R6MN

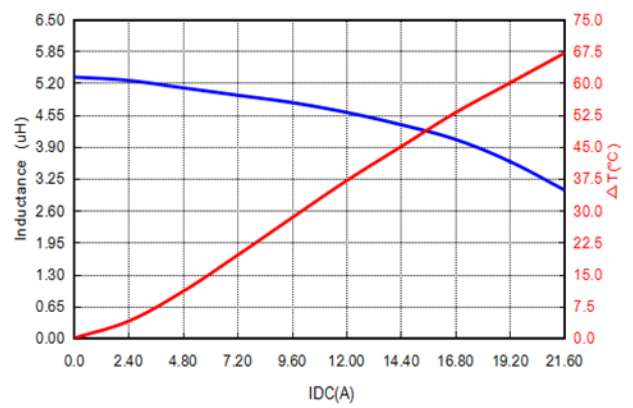

NOTE: Specifications subject to change without notice. Please check our website for latest information.

PIAQ1205SP6R8MN

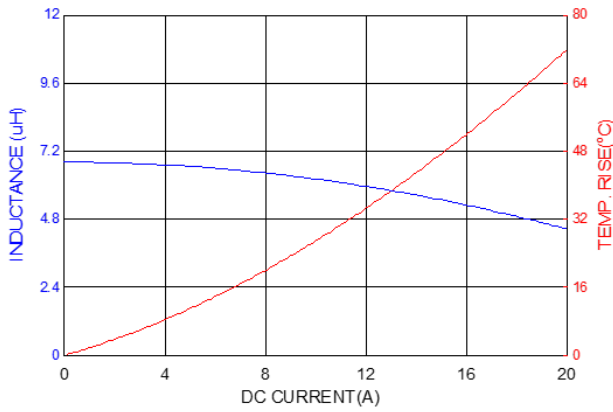

PIAQ1205SP8R2MN

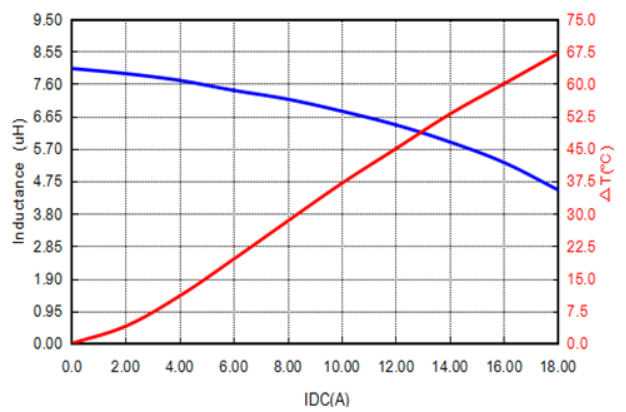

PIAQ1205SP100MN

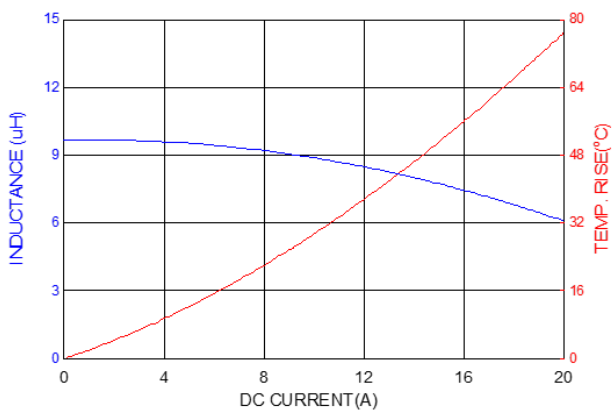

PIAQ1205SP150MN

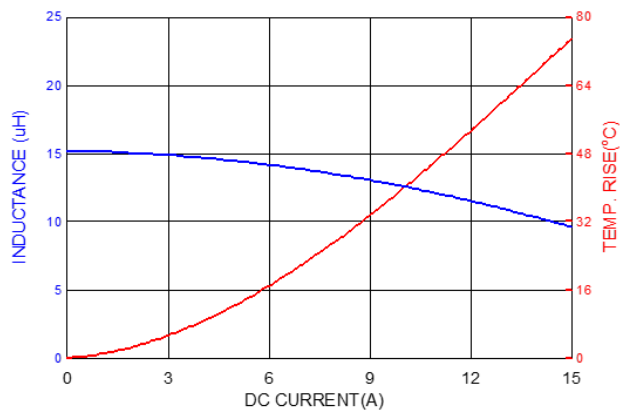

PIAQ1205SP220MN

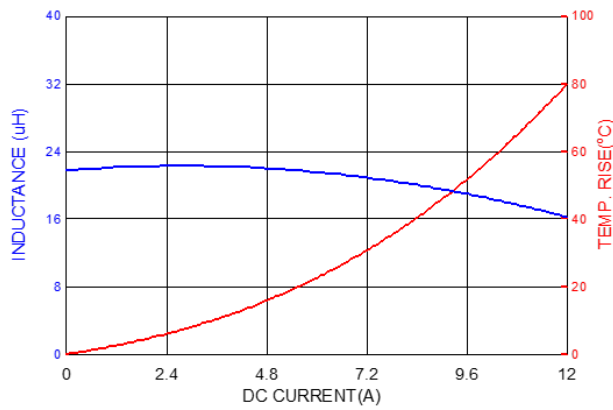

PIAQ1205SP330MN

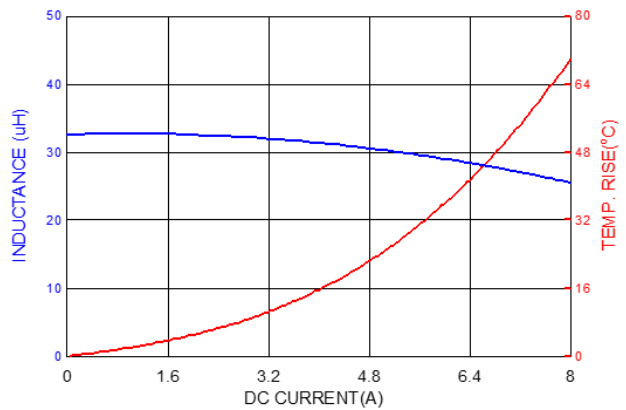

NOTE: Specifications subject to change without notice. Please check our website for latest information.

8. Soldering Specification

Mildly activated rosin fluxes are preferred. Our terminations are suitable for re-flow soldering systems. If hand soldering cannot be avoided, the preferred technique is the utilization of hot air soldering tools.

8-1. IR Soldering Reflow

Recommended temperature profiles for lead free re-flow soldering in Figure 1, Table 1.1 & 1.2 (J-STD-020E).

8-2. Iron Reflow

Products attachment with a soldering iron is discouraged due to the inherent process control limitations. In the event that a soldering iron must be employed the following precautions are recommended (Figure 2).

Note:

- (a) Preheat circuit and products to 150°C.
- (b) 355°C tip temperature (Max.)
- (c) Never contact the ceramic with the iron tip
- (d) 1.0mm tip diameter (Max.)
- (e) Use a 20 watt soldering iron with tip diameter of 1.0mm
- (f) Limit soldering time to 4~5 sec.

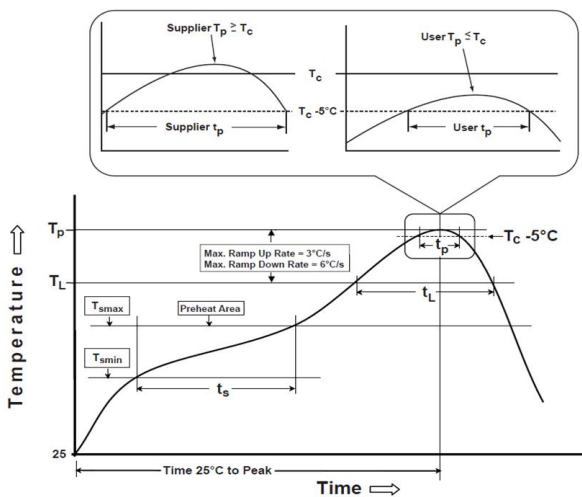

Reflow times: 3 times Max

Figure 1: IR Soldering Reflow

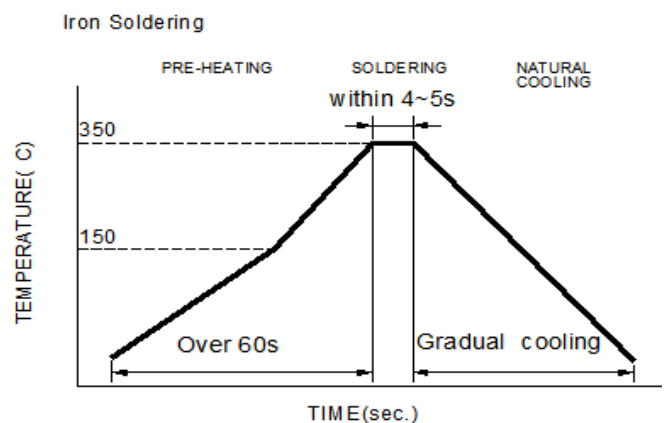

Iron Soldering times: 1 times max.

Soldering iron method: 350±5°C Max

Figure 2: Iron soldering temperature profiles

NOTE: Specifications subject to change without notice. Please check our website for latest information.

Table (1.1) Reflow Profiles

Profile Type:	Pb-Free Assembly
Preheat	
-Temperature Min (T_{smin})	150°C
-Temperature Max (T_{smax})	200°C
-Time (t_s) from (T_{smin} to T_{smax})	60-120seconds
Ramp-up rate (T_L to T_p)	3°C /second max.
Liquids temperature (T_L)	217°C
Time (t_L) maintained above T_L	60-150 seconds
Classification temperature (T_c)	See Table (1.2)
Time (t_p) at $T_c - 5^\circ\text{C}$ (T_p should be equal to or less than T_c .)	* < 30 seconds
Ramp-down rate (T_p to T_L)	6°C /second max.
Time 25°C to peak temperature	8 minutes max.

T_p: maximum peak package body temperature, **T_c**: the classification temperature.

For user (customer) **T_p** should be equal to or less than **T_c**.

*Tolerance for peak profile temperature (T_p) is defined as a supplier minimum and a user maximum.

Table (1.2) Package Thickness/Volume and Classification Temperature (T_c)

	Package Thickness	Volume mm ³ <350	Volume mm ³ 350-2000	Volume mm ³ >2000
PB-Free Assembly	<1.6mm	260°C	260°C	260°C
	1.6-2.5mm	260°C	250°C	245°C
	≥2.5mm	250°C	245°C	245°C

Reflow is referred to standard IPC/JEDEC J-STD-020E.

NOTE: Specifications subject to change without notice. Please check our website for latest information.

9. Packaging Information

9-1. Reel Dimension (Unit: mm)

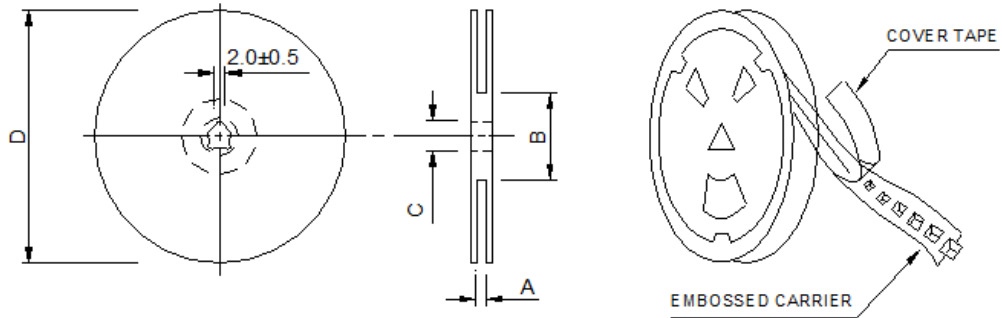

Type	A	B	C	D
13"x24mm	24.4+2.0/-0.0	100.0±2.0	13.0+0.5/-0.2	330.0

9-2. Tape Dimension (Unit: mm)

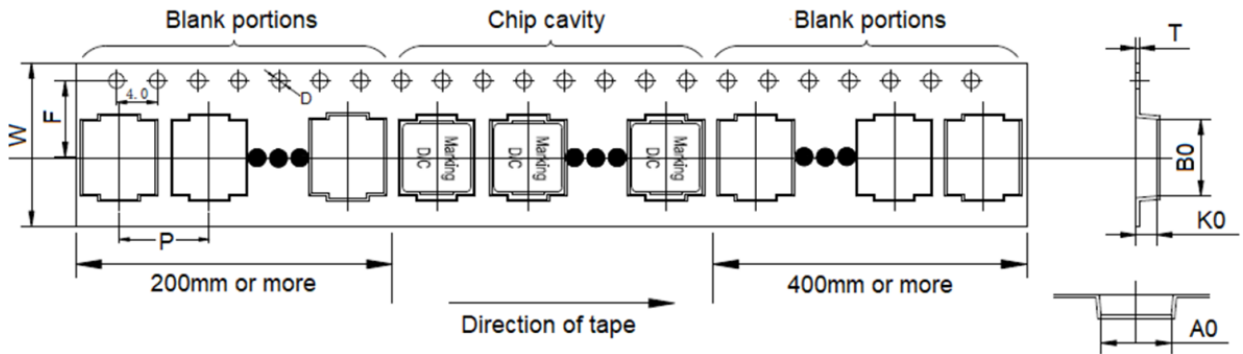

B0	A0	K0	P
14.10±0.10	12.90±0.10	5.50±0.10	16.00±0.10
W	F	T	D
24.00±0.30	11.50±0.10	0.35±0.05	1.50±0.10

NOTE: Specifications subject to change without notice. Please check our website for latest information.

9-3. Packaging Quantity (Unit: Pcs)

Chip/ Reel	500
Inner box	1,000
Carton	4,000

9-4. Tearing Off Force

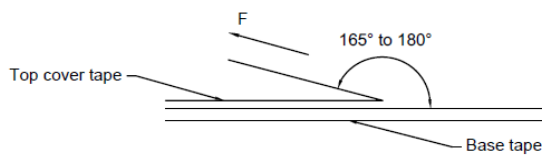

The force for tearing off cover tape is according to the follow table, in the arrow direction under the following conditions.

(Referenced ANSI/EIA-481-D-2008 of 4.11 standard)

Room Temp. (°C)	Room Humidity (%)	Room atm (hPa)	Tearing Speed (mm/min)
5~35	45~85	860~1060	300±10

Tape Size	8 mm	12 to 56 mm	72 mm or Wider
Tearing Off Force (grams)	10~100	10~130	10~150

Application Notice

1. Storage Conditions

To maintain the solderability of terminal electrodes:

- (a) Recommended products should be used within 12 months from the time of delivery.
- (b) The packaging material should be kept where no chlorine or sulfur exists in the air.

2. Transportation

- (a) Products should be handled with care to avoid damage or contamination from perspiration and skin oils.
- (b) Vacuum pick up is strongly recommended for individual components.
- (c) Bulk handling should ensure that abrasion and mechanical shock are minimized.

NOTE: Specifications subject to change without notice. Please check our website for latest information.