

1. Part No. Expression

SMC 1007 R17 L A F

(a) (b) (c) (d) (e) (f)

- (a) Series Code
- (b) Dimension Code
- (c) Inductance Code
- (d) Tolerance Code
- (e) Special Code
- (f) Packaging Code

2. Configuration & Dimensions (Unit: mm)

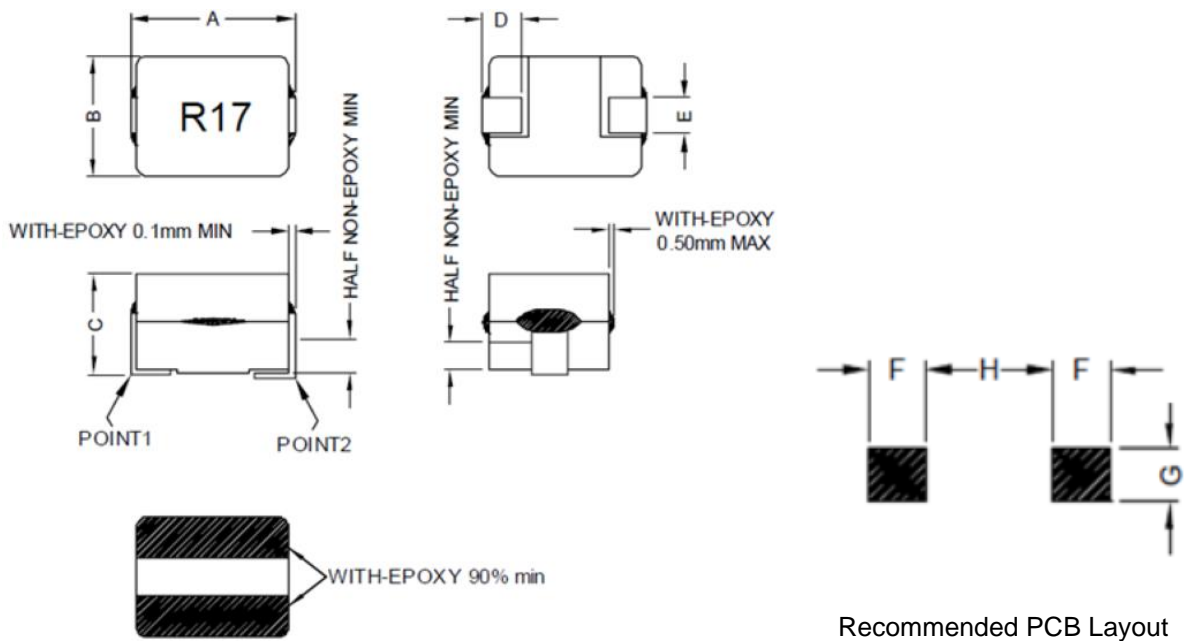

- Note:
1. The above PCB layout reference only.
 2. Marking: Inductance Code

A	B	C	D	E	F	G	H
10.40 Max	8.00 Max	7.30±0.30	2.54±0.30	2.30±0.20	3.29 Ref	2.79 Ref	4.32 Ref

NOTE: Specifications subject to change without notice. Please check our website for latest information.

3. Schematic



4. Material List

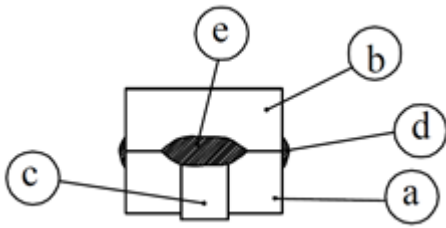

- (a) Core
- (b) Core
- (c) Clip
- (d) Adhesive
- (e) Adhesive

5. General Specifications

- (a) Operating Temp.: -40°C to +125°C (including self-temperature rise)
- (b) All test data referenced to 25°C ambient.
- (c) Heat Rated Current (I_{rms}) will cause the coil temperature rise ΔT of 40°C Max.
- (d) Saturation Current (I_{sat}) will cause inductance L₀ to drop approximately 30%.
- (e) Storage Condition (Component in its packaging)
 - i) Temperature: -10°C to +40°C
 - ii) Humidity: Less than 60% RH

6. Electrical Characteristics

Part Number	Inductance (uH) @0A	Test Frequency	DCR (mΩ) ±10	I _{sat} (A)	I _{rms} (A)
SMC1007R17LAF	0.17	1V/100KHz	0.29	60	61
SMC1007R22KAF	0.215	1V/100KHz	0.29	44	61

Tolerance Code: K= ±10%, L= 15%

NOTE: Specifications subject to change without notice. Please check our website for latest information.

7. Characteristics Curve

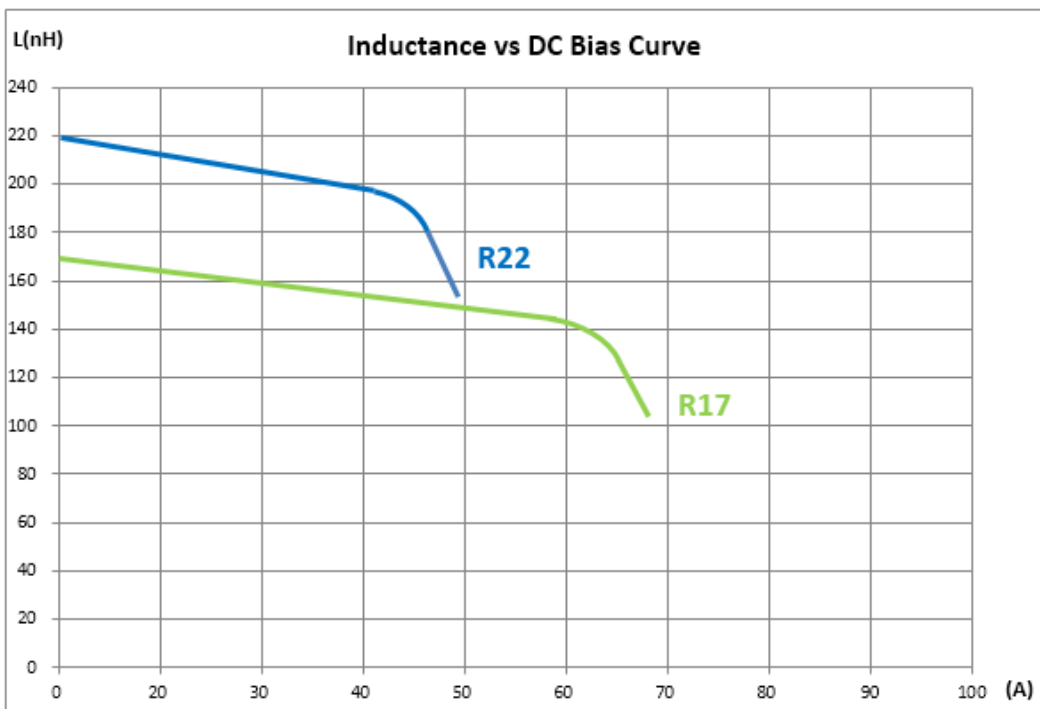
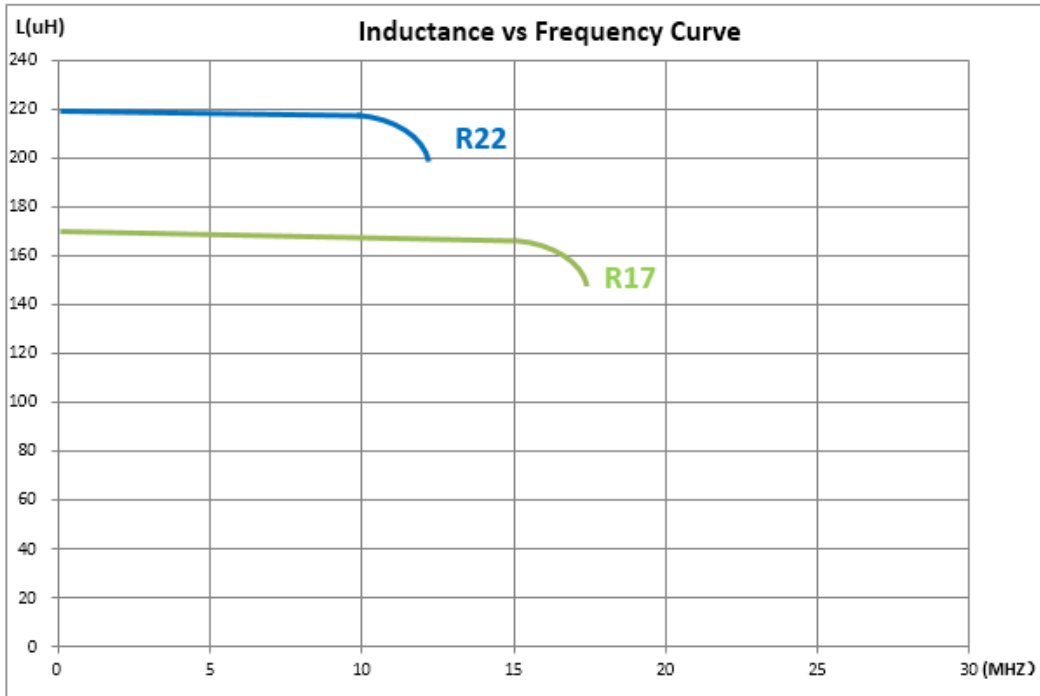

NOTE: Specifications subject to change without notice. Please check our website for latest information.

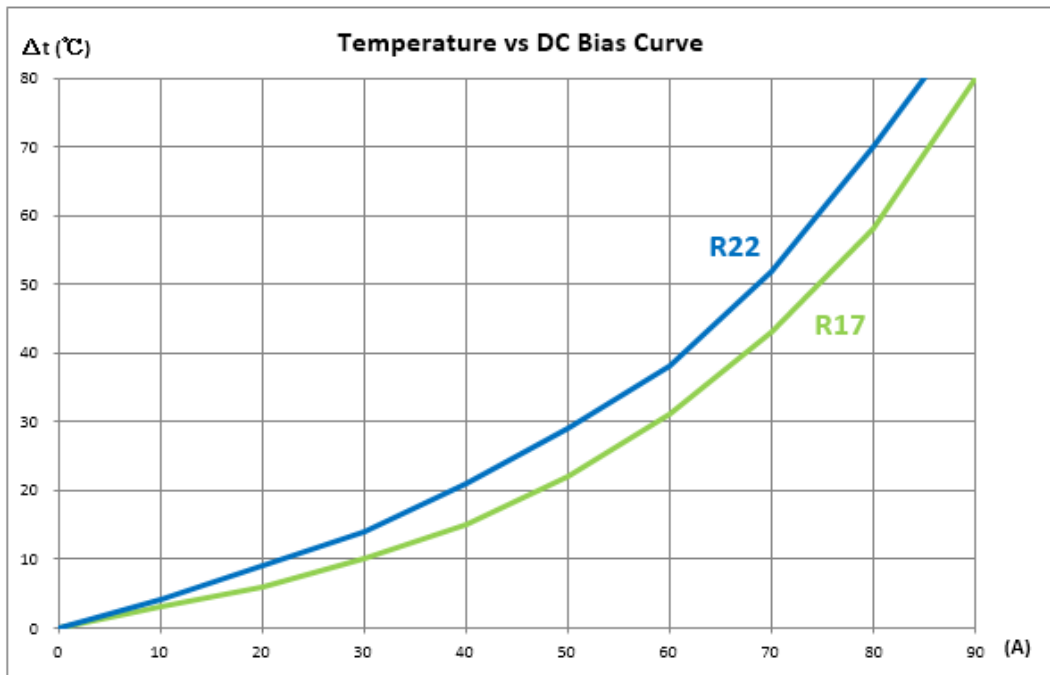

NOTE: Specifications subject to change without notice. Please check our website for latest information.

8. Soldering Specification

Mildly activated rosin fluxes are preferred. Our terminations are suitable for re-flow soldering systems. If hand soldering cannot be avoided, the preferred technique is the utilization of hot air soldering tools.

8-1. IR Soldering Reflow

Recommended temperature profiles for lead free re-flow soldering in Figure 1, Table 1.1 & 1.2 (J-STD-020E).

8-2. Iron Reflow

Products attachment with a soldering iron is discouraged due to the inherent process control limitations. In the event that a soldering iron must be employed the following precautions are recommended (Figure 2).

Note:

- (a) Preheat circuit and products to 150°C.
- (b) 355°C tip temperature (Max.)
- (c) Never contact the ceramic with the iron tip
- (d) 1.0mm tip diameter (Max.)
- (e) Use a 20 watt soldering iron with tip diameter of 1.0mm
- (f) Limit soldering time to 4~5 sec.

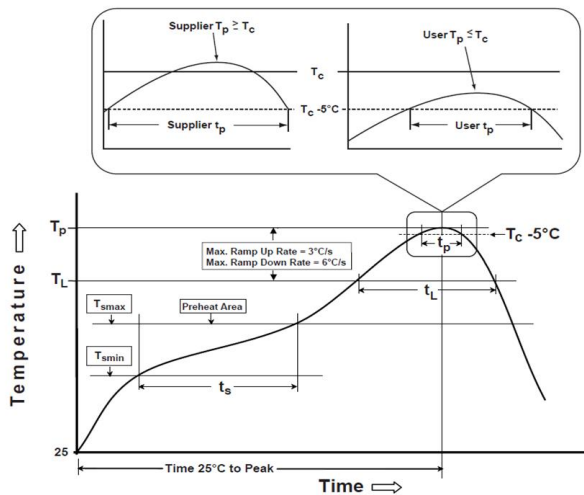

Reflow times: 3 times Max

Figure 1: IR Soldering Reflow

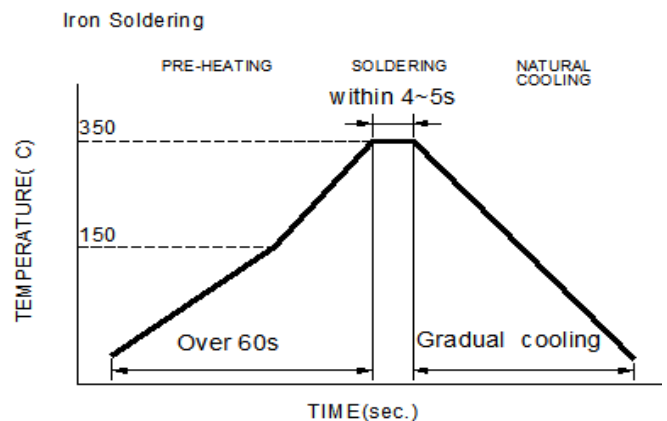

Soldering iron method: 350±5°C Max

Figure 2: Iron soldering temperature profiles

NOTE: Specifications subject to change without notice. Please check our website for latest information.

Table (1.1) Reflow Profiles

Profile Type:	Pb-Free Assembly
Preheat	
-Temperature Min (T_{smin})	150°C
-Temperature Max (T_{smax})	200°C
-Time (t_s) from (T_{smin} to T_{smax})	60-120seconds
Ramp-up rate (T_L to T_p)	3°C /second max.
Liquids temperature (T_L)	217°C
Time (t_L) maintained above T_L	60-150 seconds
Classification temperature (T_c)	See Table (1.2)
Time (t_p) at $T_c - 5^\circ\text{C}$ (T_p should be equal to or less than T_c .)	* < 30 seconds
Ramp-down rate (T_p to T_L)	6°C /second max.
Time 25°C to peak temperature	8 minutes max.

T_p: maximum peak package body temperature, **T_c**: the classification temperature.

For user (customer) **T_p** should be equal to or less than **T_c**.

*Tolerance for peak profile temperature (T_p) is defined as a supplier minimum and a user maximum.

Table (1.2) Package Thickness/Volume and Classification Temperature (T_c)

	Package Thickness	Volume mm ³ <350	Volume mm ³ 350-2000	Volume mm ³ >2000
PB-Free Assembly	<1.6mm	260°C	260°C	260°C
	1.6-2.5mm	260°C	250°C	245°C
	≥2.5mm	250°C	245°C	245°C

Reflow is referred to standard IPC/JEDEC J-STD-020E.

NOTE: Specifications subject to change without notice. Please check our website for latest information.

9. Packaging Information

9-1. Reel Dimension (Unit: mm)

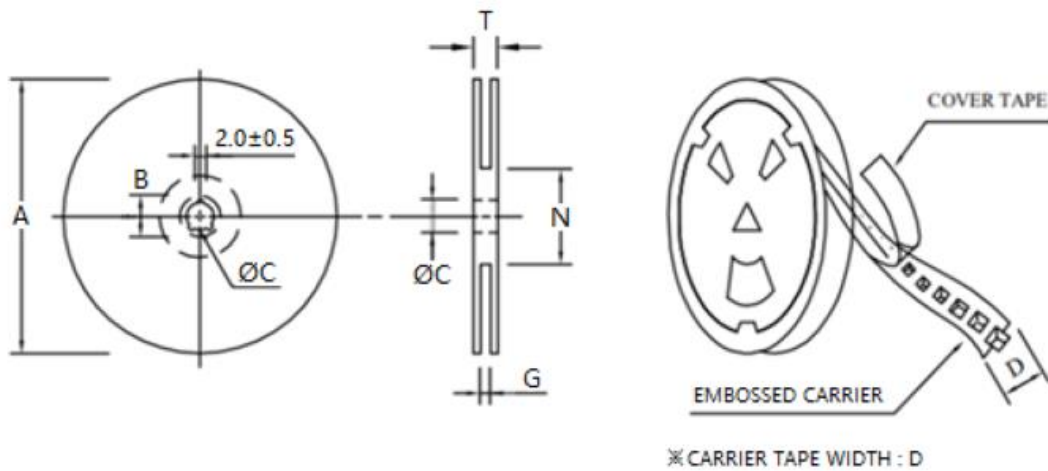

Type	A	B	C	D	G	N	T
13"x24mm	330.0	21.0 \pm 0.8	13.0 \pm 0.5	24.0	26.0 Max	50.0 Min	30.4

9-2. Tape Dimension (Unit: mm)

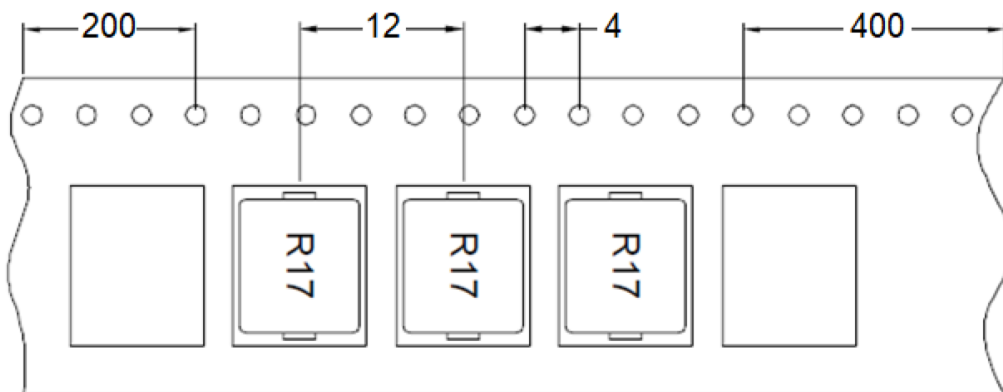

NOTE: Specifications subject to change without notice. Please check our website for latest information.

9-3. Packaging Quantity (Unit: Pcs) & G.W. Per Package

Inner: Reel			Outer: Carton		
Qty (pcs)	G.W (gw)	Style	Qty (pcs)	G.W (kg)	Size (cm)
500	1,575	13-24	2,000	7.3	38*36.5*21

9-4. Tearing Off Force

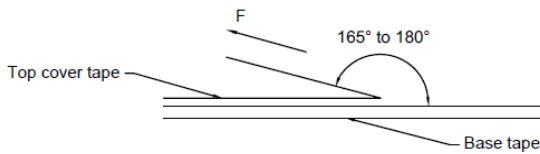

The force for tearing off cover tape is according to the follow table, in the arrow direction under the following conditions.

(Referenced ANSI/EIA-481-D-2008 of 4.11 standard)

Room Temp. (°C)	Room Humidity (%)	Room atm (hPa)	Tearing Speed (mm/min)
5~35	45~85	860~1060	300±10

Tape Size	8 mm	12 to 56 mm	72 mm or Wider
Tearing Off Force (grams)	10~100	10~130	10~150

Application Notice

1. Storage Conditions

To maintain the solderability of terminal electrodes:

- (a) Recommended products should be used within 12 months from the time of delivery.
- (b) The packaging material should be kept where no chlorine or sulfur exists in the air.

2. Transportation

- (a) Products should be handled with care to avoid damage or contamination from perspiration and skin oils.
- (b) Vacuum pick up is strongly recommended for individual components.
- (c) Bulk handling should ensure that abrasion and mechanical shock are minimized.

NOTE: Specifications subject to change without notice. Please check our website for latest information.