

1. Part No. Expression

PIC8040HPR22MF

(a) (b) (c) (d) (e) (f)

- | | |
|--------------------|---------------------|
| (a) Series Code | (d) Inductance Code |
| (b) Dimension Code | (e) Tolerance Code |
| (c) Material Code | (f) Packaging Code |

2. Configuration & Dimensions (Unit: mm)

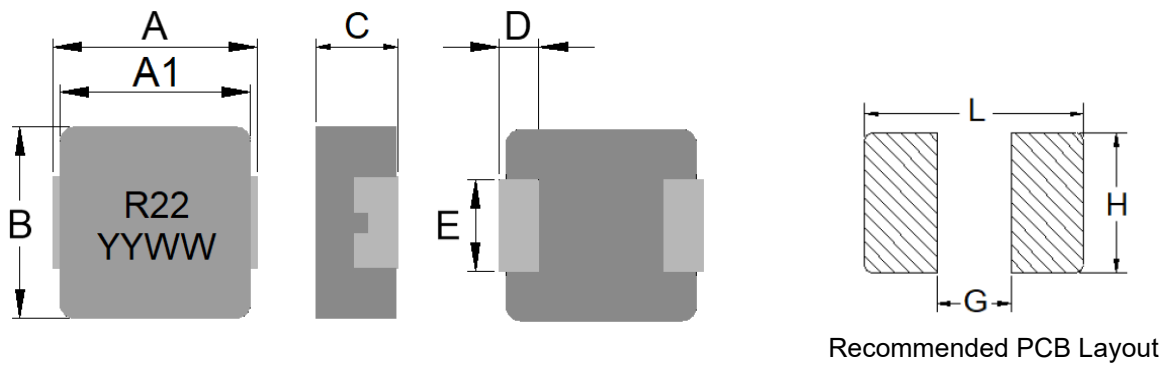

- Note:
1. The above PCB layout reference only.
 2. Recommend solder paste thickness at 0.15 mm and above.
 3. Marking: Top= Inductance Code, Bottom=YYWW (Year/World week), Black

A	A1	B	C	D
8.8±0.4	8.1±0.2	8.4±0.3	3.8±0.2	1.6±0.3
E	L	G	H	-
5.0±0.3	9.6 Ref	4.5 Ref	5.5 Ref	-

NOTE: Specifications subject to change without notice. Please check our website for latest information.

3. Schematic

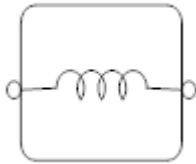

4. Material List

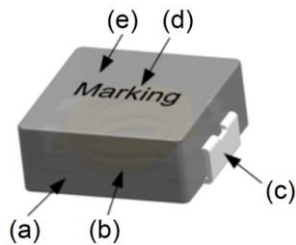

NO	Items
(a)	Core
(b)	Wire
(c)	Clip
(d)	Ink
(e)	Paint

5. General Specifications

- (a) Operating Temp.: - 40°C to + 125°C (including self-temperature rise)
- (b) Storage Temp.: - 40°C to + 125°C (on board)
- (c) All test data referenced to 25°C ambient.
- (d) Heat Rated Current (Irms) will cause the coil temperature rise approximately ΔT of 40°C.
- (e) Saturation Current (Isat) will cause inductance L0 to drop approximately 30%.
- (f) Rated DC Current: The lower value of Irms and Isat.
- (g) Part Temperature (Ambient + Temp. Rise): Should not exceed 125°C under worst case operating conditions.
- (h) Maximum Operating Voltage: 80V
- (i) Storage Condition (Component in its packaging)
 - i) Temperature: Less than 40°C
 - ii) Humidity: Less than 60% RH

NOTE: Specifications subject to change without notice. Please check our website for latest information.

6. Electrical Characteristics

Part Number	Inductance (μ H) @0A \pm 20%	Test Frequency	I _{rms} (A) Typ	I _{sat} (A) Typ	DCR (m Ω)	
					Typ	Max
PIC8040HPR22MF	0.22	1.0V/100KHz	31	60	1.6	1.76
PIC8040HPR33MF	0.33	1.0V/100KHz	30	55	2.0	2.20
PIC8040HPR47MF	0.47	1.0V/100KHz	28	40	2.6	2.86
PIC8040HPR56MF	0.56	1.0V/100KHz	25	38	2.7	2.97
PIC8040HPR68MF	0.68	1.0V/100KHz	23	36	3.1	3.41
PIC8040HPR82MF	0.82	1.0V/100KHz	21	32	3.7	4.10
PIC8040HP1R0MF	1.0	1.0V/100KHz	18	29	4.5	4.95
PIC8040HP1R5MF	1.5	1.0V/100KHz	17	27	6.6	7.30
PIC8040HP2R2MF	2.2	1.0V/100KHz	16	25	10.8	11.9
PIC8040HP3R3MF	3.3	1.0V/100KHz	14	22	15.0	16.5
PIC8040HP4R7MF	4.7	1.0V/100KHz	8.5	19	26.8	29.5
PIC8040HP5R6MF	5.6	1.0V/100KHz	7.5	17	30	35
PIC8040HP6R8MF	6.8	1.0V/100KHz	6.5	16.5	40	46
PIC8040HP8R2MF	8.2	1.0V/100KHz	6.0	16	44	51
PIC8040HP100MF	10.0	1.0V/100KHz	5.6	10	53	61

NOTE: Specifications subject to change without notice. Please check our website for latest information.

7. Characteristics Curve

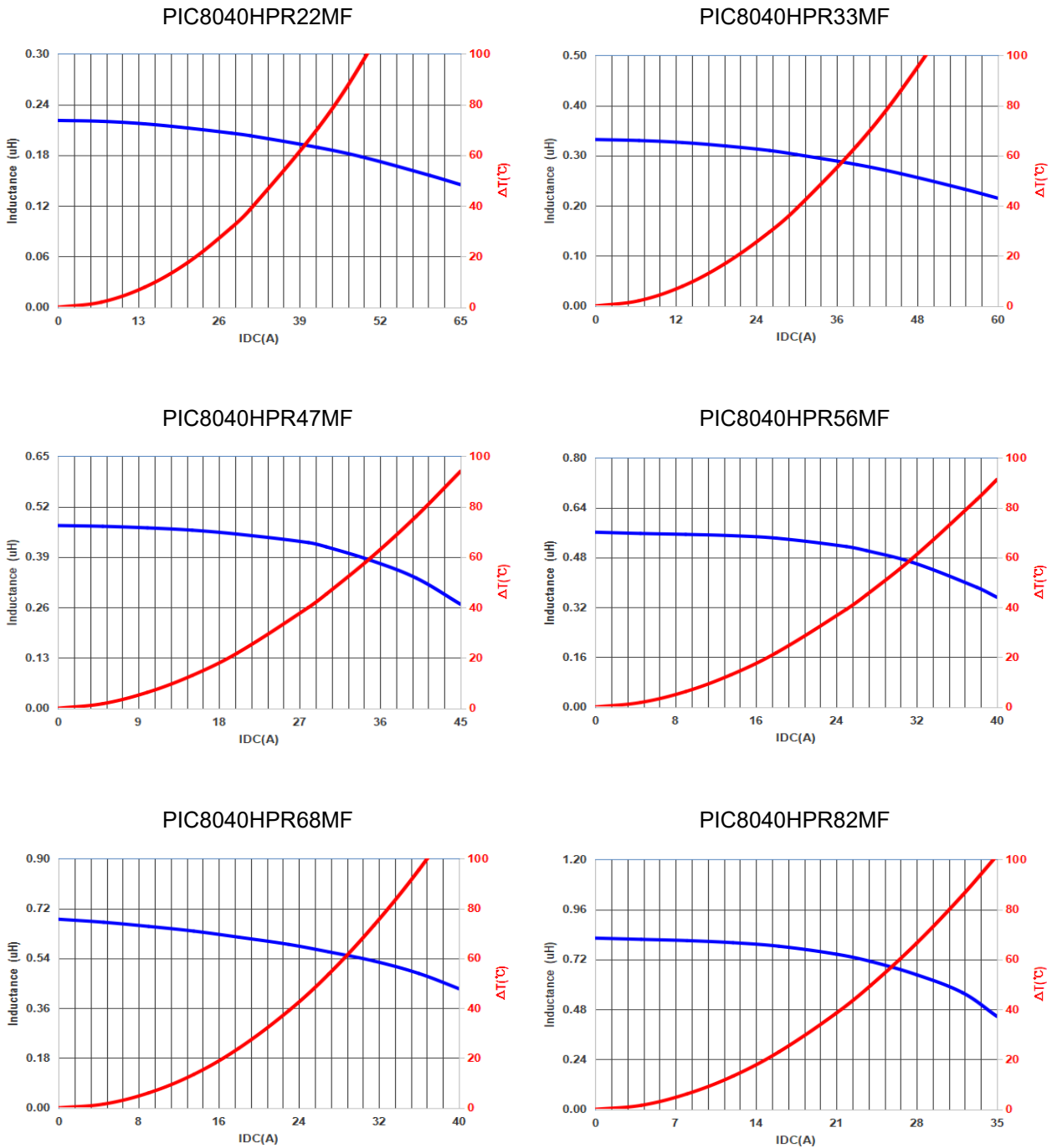

NOTE: Specifications subject to change without notice. Please check our website for latest information.

PIC8040HP1R0MF

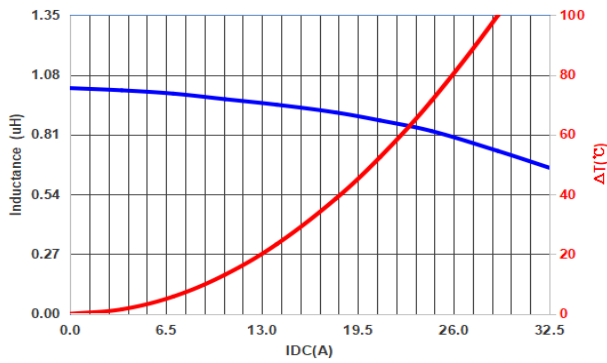

PIC8040HP1R5MF

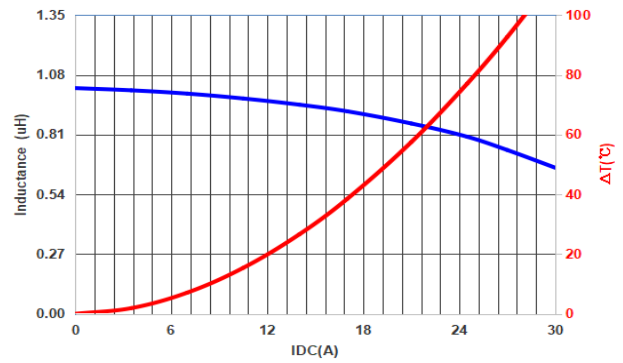

PIC8040HP2R2MF

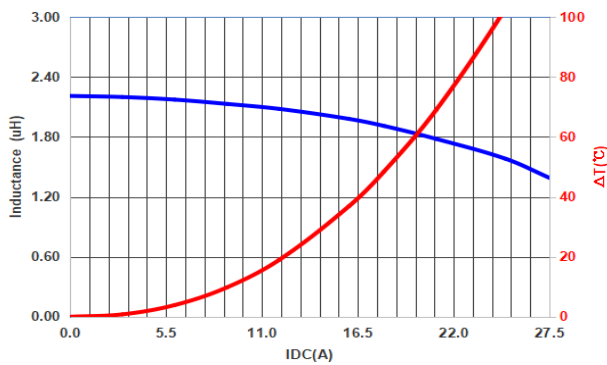

PIC8040HP3R3MF

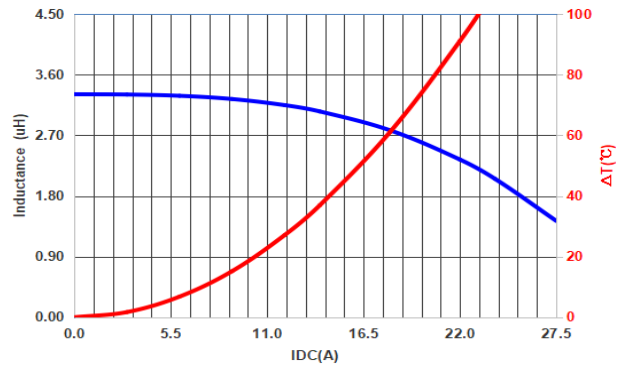

PIC8040HP4R7MF

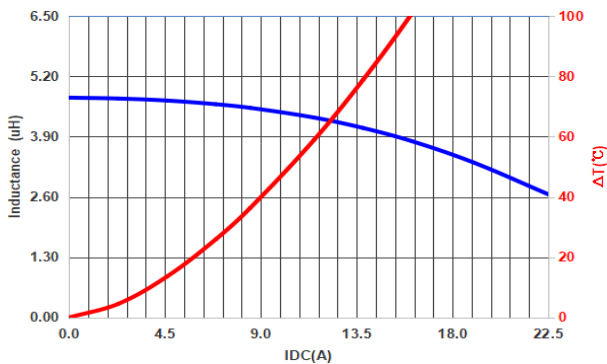

PIC8040HP5R6MF

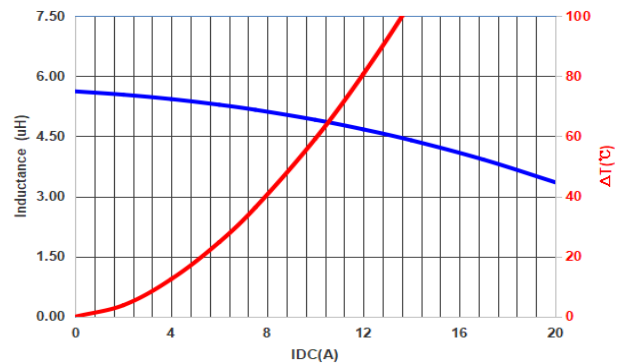

NOTE: Specifications subject to change without notice. Please check our website for latest information.

PIC8040HP6R8MF

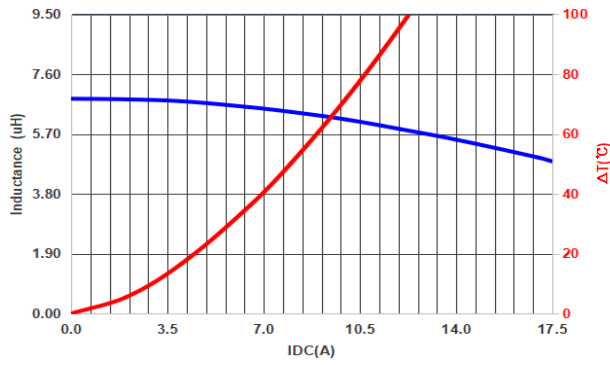

PIC8040HP8R2MF

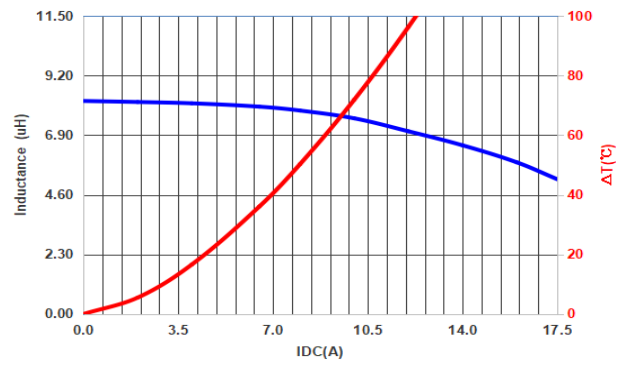

PIC8040HP100MF

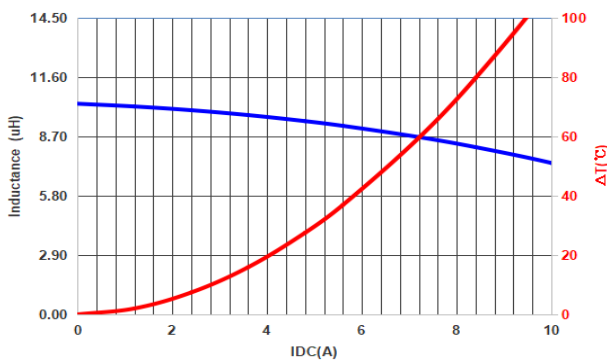

NOTE: Specifications subject to change without notice. Please check our website for latest information.

8. Soldering Specification

Mildly activated rosin fluxes are preferred. Our terminations are suitable for re-flow soldering systems. If hand soldering cannot be avoided, the preferred technique is the utilization of hot air soldering tools.

8-1. IR Soldering Reflow

Recommended temperature profiles for lead free re-flow soldering in Figure 1, Table 1.1 & 1.2 (J-STD-020F).

8-2. Iron Reflow

Products attachment with a soldering iron is discouraged due to the inherent process control limitations. In the event that a soldering iron must be employed the following precautions are recommended (Figure 2).

Note:

- (a) Preheat circuit and products to 150°C.
- (b) 350°C tip temperature (Max.)
- (c) Never contact the ceramic with the iron tip
- (d) 1.0mm tip diameter (Max.)
- (e) Use a 20 watt soldering iron with tip diameter of 1.0mm
- (f) Limit soldering time to 4~5 sec.

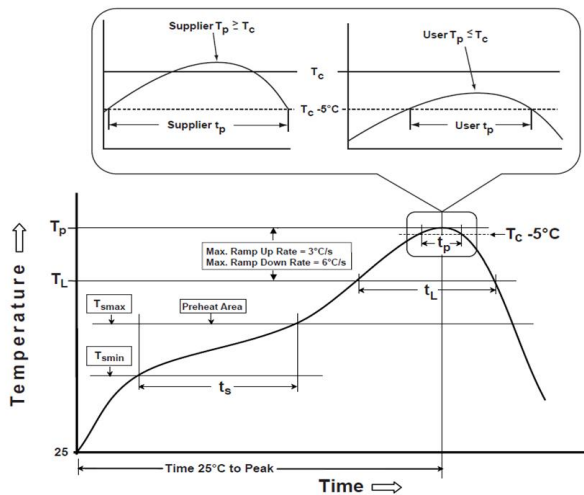

Reflow times: 3 times Max

Figure 1: IR Soldering Reflow

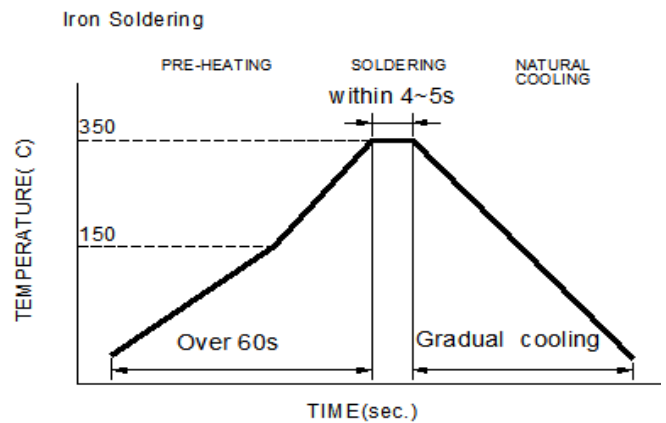

Iron Soldering times : 1 times max

Figure 2: Iron soldering temperature profiles

NOTE: Specifications subject to change without notice. Please check our website for latest information.

Table (1.1) Reflow Profiles

Profile Type:	Pb-Free Assembly
Preheat	
-Temperature Min (T_{smin})	150°C
-Temperature Max (T_{smax})	200°C
-Time (t_s) from (T_{smin} to T_{smax})	60-120seconds
Ramp-up rate (T_L to T_p)	3°C /second max.
Liquids temperature (T_L)	217°C
Time (t_L) maintained above T_L	60-150 seconds
Classification temperature (T_c)	See Table (1.2)
Time (t_p) at $T_c - 5^\circ\text{C}$ (T_p should be equal to or less than T_c .)	< 30 seconds
Ramp-down rate (T_p to T_L)	6°C /second max.
Time 25°C to peak temperature	8 minutes max.

T_p: maximum peak package body temperature, **T_c**: the classification temperature.

For user (customer) **T_p** should be equal to or less than **T_c**.

Table (1.2) Package Thickness/Volume and Classification Temperature (T_c)

	Package Thickness	Volume mm ³ <350	Volume mm ³ 350-2000	Volume mm ³ >2000
PB-Free Assembly	<1.6mm	260°C	260°C	260°C
	1.6-2.5mm	260°C	250°C	245°C
	≥2.5mm	250°C	245°C	245°C

Reflow is referred to standard IPC/JEDEC J-STD-020F.

8-3. Soldering Volume

Accordingly increasing the solder volume, the mechanical stress to product is also increased. Exceeding solder volume may cause the failure of mechanical or electrical performance. Solder shall be used not to be exceeded as shown in the Figure below.

Minimum fillet height = soldering thickness + 25% product height.

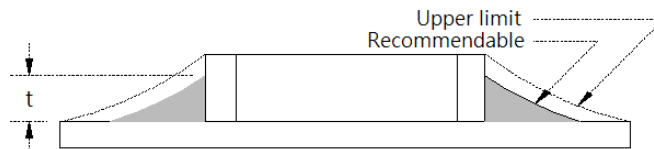

NOTE: Specifications subject to change without notice. Please check our website for latest information.

9. Packaging Information

9-1. Reel Dimension (Unit: mm)

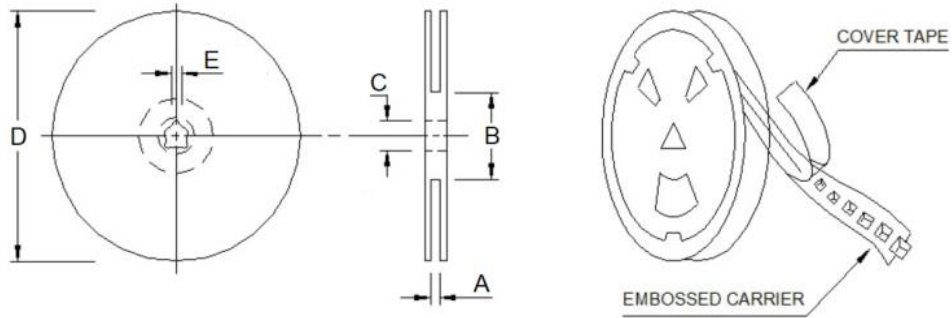

Type	A	B	C	D	E
13"x24mm	24.4 Ref	100.0 Ref	13.0 Ref	330.0 Ref	2.0 Ref

9-2. Tape Dimension (Unit: mm)

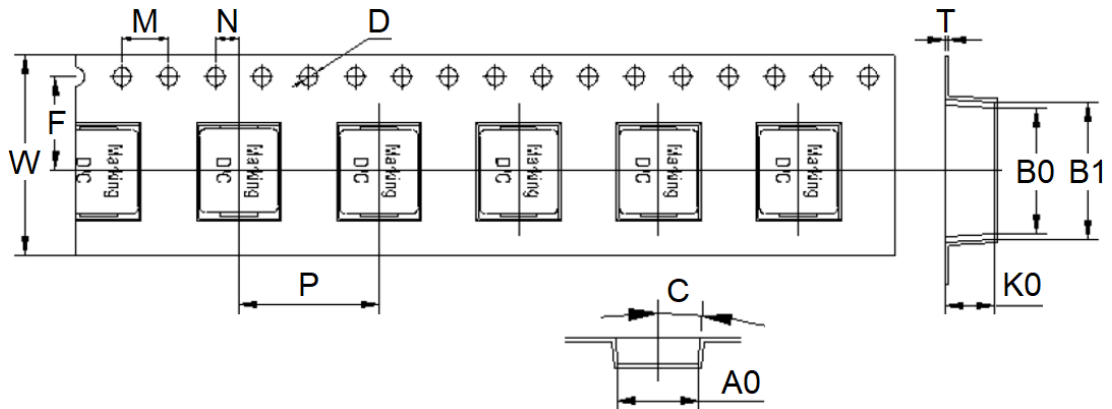

B1	B0	A0	K0	P	W
10.10±0.10	9.00±0.10	8.90±0.10	4.50±0.10	16.00±0.10	24.00±0.30
F	T	D	M	N	C
11.50±0.10	0.35±0.05	1.50±0.10	4.00	2.00	3°

NOTE: Specifications subject to change without notice. Please check our website for latest information.

9-3. Packaging Quantity (Unit: Pcs)

Chip/ Reel	800
Inner box	1,600
Carton	6,400

9-4. Tearing Off Force

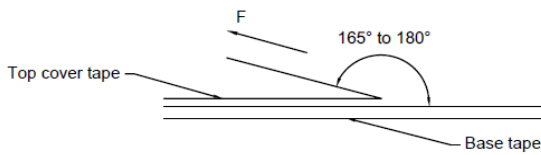

The force for tearing off cover tape is according to the follow table, in the arrow direction under the following conditions.

(Referenced ANSI/EIA-481-D-2008 of 4.11 standard)

Room Temp. (°C)	Room Humidity (%)	Room atm (hPa)	Tearing Speed (mm/min)
5~35	45~85	860~1060	300±10

Tape Size	8 mm	12 to 56 mm	72 mm or Wider
Tearing Off Force (grams)	10~100	10~130	10~150

Application Notice

1. Storage Conditions

To maintain the solderability of terminal electrodes:

- (a) Products meet IPC/JEDEC J-STD-020F standard-MSL, level 1.
- (b) Recommended products should be used within 12 months from the time of delivery.
- (c) The packaging material should be kept where no chlorine or sulfur exists in the air.

2. Transportation

- (a) Products should be handled with care to avoid damage or contamination from perspiration and skin oils.
- (b) Vacuum pick up is strongly recommended for individual components.
- (c) Bulk handling should ensure that abrasion and mechanical shock are minimized.

NOTE: Specifications subject to change without notice. Please check our website for latest information.