

1. Part No. Expression

S M F 1 1 0 5 1 1 R 0 7 L Z F

(a) (b) (c) (d) (e) (f)

- | | |
|---------------------|--------------------|
| (a) Series Code | (d) Tolerance Code |
| (b) Dimension Code | (e) Special Code |
| (c) Inductance Code | (f) Packaging Code |

2. Configuration & Dimensions (Unit: mm)

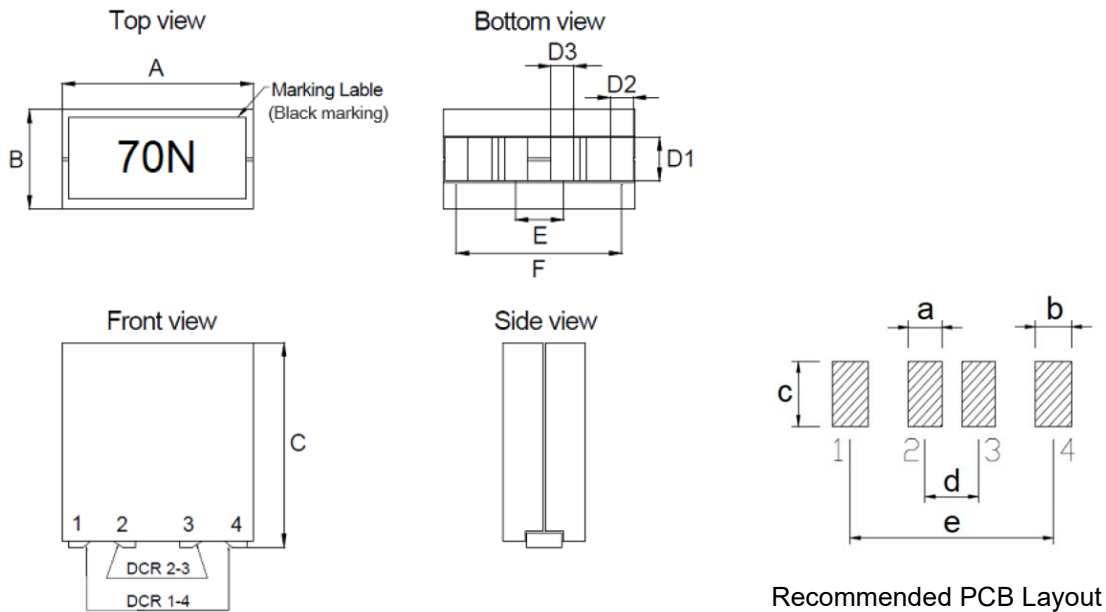

- Note:
1. Marking: Inductance (Please refer to Electrical Characteristics table)
 2. PAD surface flatness 0.1mm max.
 3. Recommended: modules should be surface-mounted on the second time (last time) of customer's double-sided PCB to prevent shift of parts.
 4. Before soldering, be sure to preheat components. The recommended preheating condition is 150°C for 3 minutes.

A	B	C	D1	D2	D3	E
11.70±0.30	5.70±0.30	11.00±0.20	2.45±0.30	1.30±0.30	1.15±0.30	2.65±0.50
F	a	b	c	d	e	-
10.10±0.50	1.65 Ref	1.80 Ref	2.95 Ref	2.65 Ref	10.10 Ref	-

NOTE: Specifications subject to change without notice. Please check our website for latest information.

3. Schematic

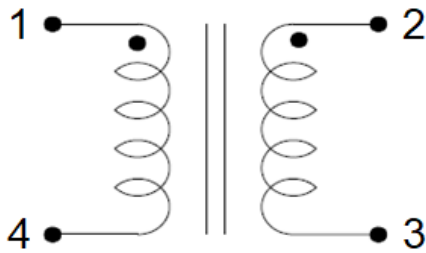

4. Material List

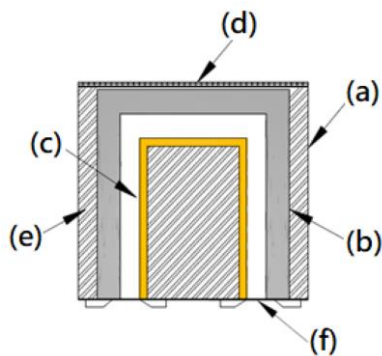

- (a) Core
- (b) Clip
- (c) Wire
- (d) Tape
- (e) Glue
- (f) Coating

5. General Specifications

- (a) Operating Temp.: -40°C to +125°C (including self-temperature rise)
- (b) Storage Temp.: -40°C to +125°C (on board)
- (c) All test data referenced to 25°C ambient.
- (d) Heat Rated Current (I_{rms}) will cause the coil temperature rise approximately ΔT of 40°C.
- (e) Saturation Current (I_{sat1}) will cause inductance L₀ to drop approximately 20% at +25°C.
Saturation Current (I_{sat2}) will cause inductance L₀ to drop approximately 20% at +100°C.
Saturation Current (I_{sat3}) will cause inductance L₀ to drop approximately 20% at +125°C.
- (f) Rated Current: The lower value of I_{sat} and I_{rms}.
- (g) Maximum Operating Voltage: 80V
- (h) Storage Condition (Component in its packaging)
 - i) Temperature: Less than 40°C
 - ii) Humidity: Less than 60% RH

NOTE: Specifications subject to change without notice. Please check our website for latest information.

6. Electrical Characteristics

Part Number	L(nH) 1-4/2-3 ±15%	L2(nH) Min 1-4	DCR (mΩ) ±10%		Isat1 (A) 25°C	Isat2 (A) 100°C	Isat3 (A) 125°C	I _{rms} (A)		Lk (nH) Typ	K _{ps} Typ	Marking
			1-4	2-3				1-4	2-3			
SMF110511R07LZF	70.0	47.6	0.125	0.370	160	140	130	77	45	12.0	0.92	70N
SMF110511R08LZF	80.0	54.4	0.125	0.370	150	120	110	77	45	12.0	0.92	80N
SMF110511R09LZF	90.0	61.2	0.125	0.370	135	115	105	77	45	12.0	0.93	90N
SMF110511R10LZF	105.0	71.4	0.125	0.370	125	106	98	77	45	12.0	0.94	R10
SMF110511R12LZF	120.0	81.6	0.125	0.370	102	87	80	77	45	12.0	0.95	R12
SMF110511R15LZF	150.0	102.0	0.125	0.370	84	71	58	77	45	12.0	0.95	R15
SMF110511R17LZF	170.0	115.6	0.125	0.370	70	60	53	77	45	12.0	0.96	R17
SMF110511R20LZF	200.0	136.0	0.125	0.370	58	50	43	77	45	12.0	0.96	R20

Notes:

1. L@ 1.0V/100KHz, 0A, 25°C
2. L2 @ 1.0V/100KHz, I_{SAT}
3. K_{ps}: Coupling Coefficient
4. Lk: Leakage inductance

NOTE: Specifications subject to change without notice. Please check our website for latest information.

7. Characteristics Curve

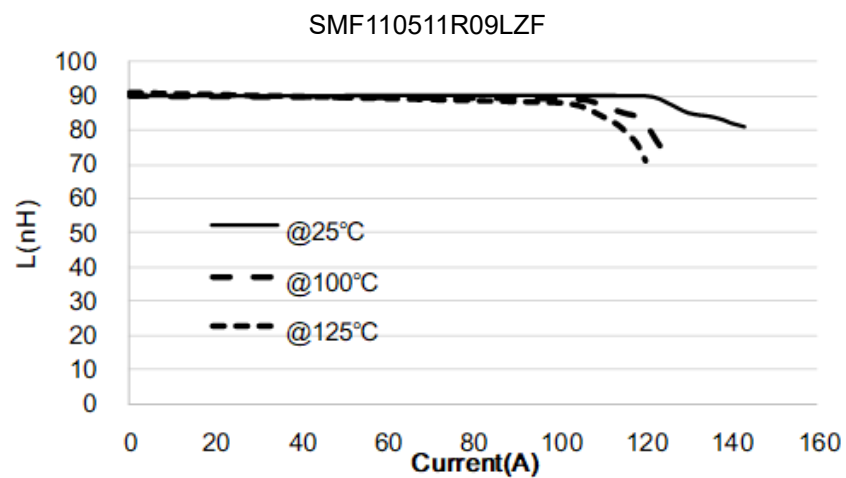
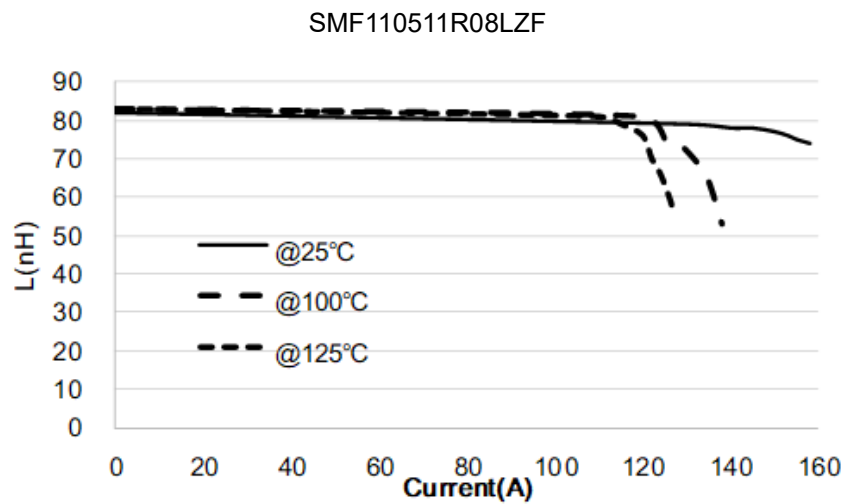
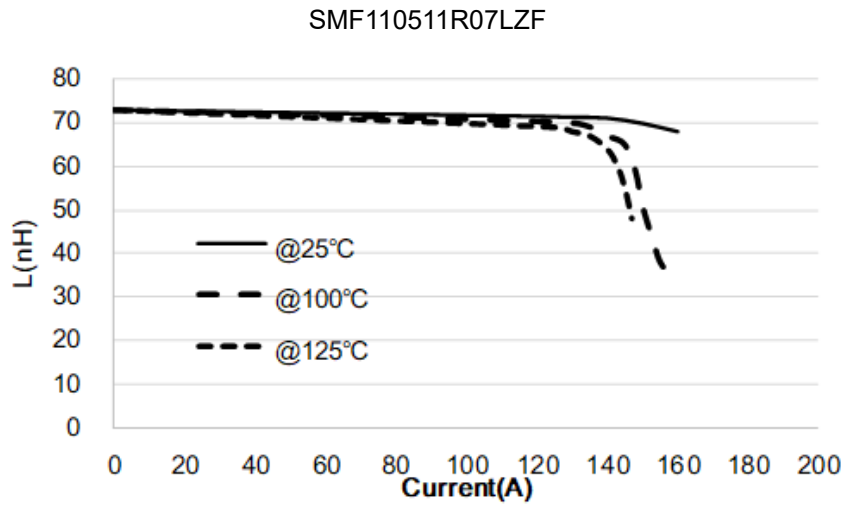

NOTE: Specifications subject to change without notice. Please check our website for latest information.

SMF110511R10LZF

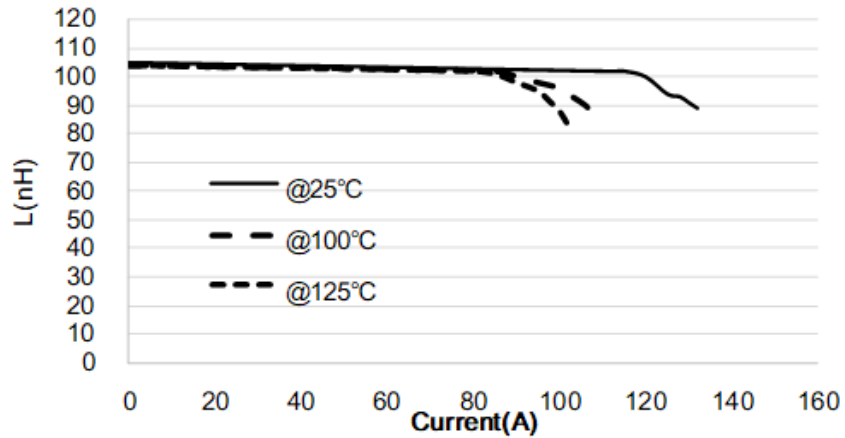

SMF110511R12LZF

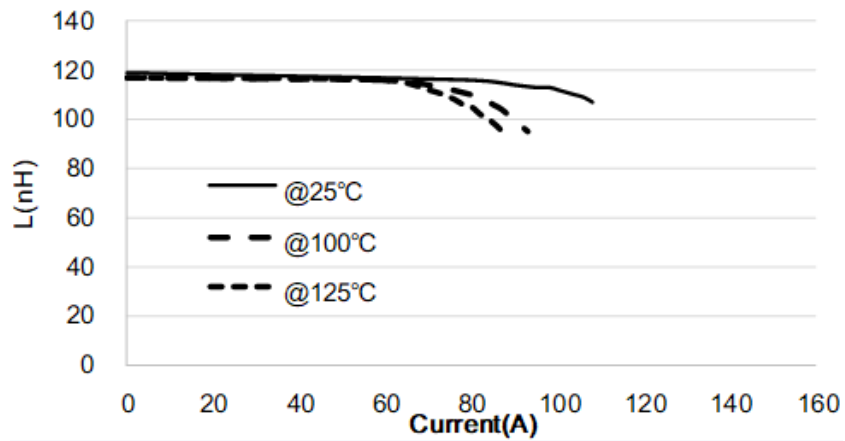

SMF110511R15LZF

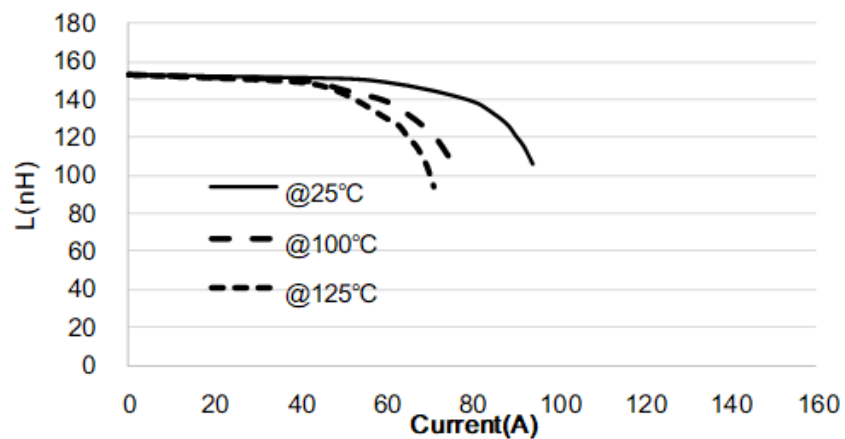

NOTE: Specifications subject to change without notice. Please check our website for latest information.

SMF110511R17LZF

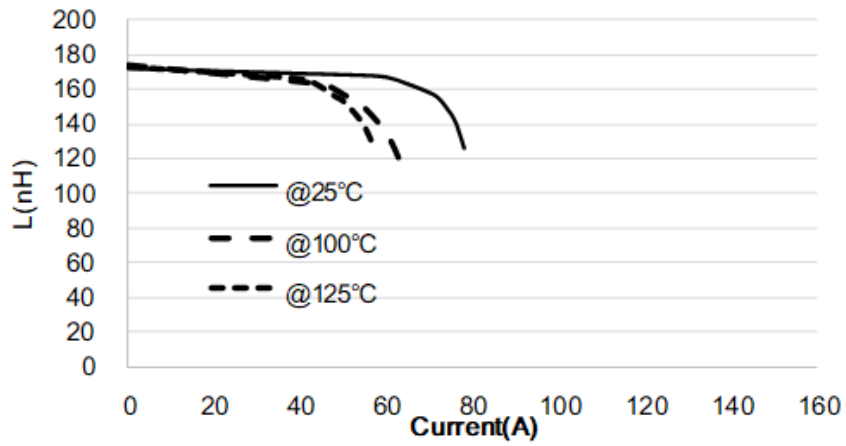

SMF110511R20LZF

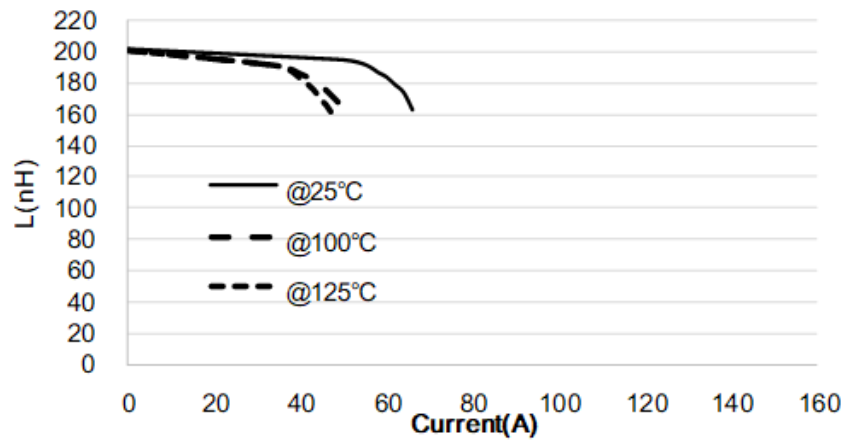

NOTE: Specifications subject to change without notice. Please check our website for latest information.

8. Soldering Specification

Mildly activated rosin fluxes are preferred. Our terminations are suitable for re-flow soldering systems. If hand soldering cannot be avoided, the preferred technique is the utilization of hot air soldering tools.

8-1. IR Soldering Reflow

Recommended temperature profiles for lead free re-flow soldering in Figure 1, Table 1.1 & 1.2 (J-STD-020F).

8-2. Iron Reflow

Products attachment with a soldering iron is discouraged due to the inherent process control limitations. In the event that a soldering iron must be employed the following precautions are recommended (Figure 2).

Note:

- (a) Preheat circuit and products to 150°C.
- (b) 350°C tip temperature (Max.)
- (c) Never contact the ceramic with the iron tip
- (d) 1.0mm tip diameter (Max.)
- (e) Use a 20 watt soldering iron with tip diameter of 1.0mm
- (f) Limit soldering time to 4~5 sec.

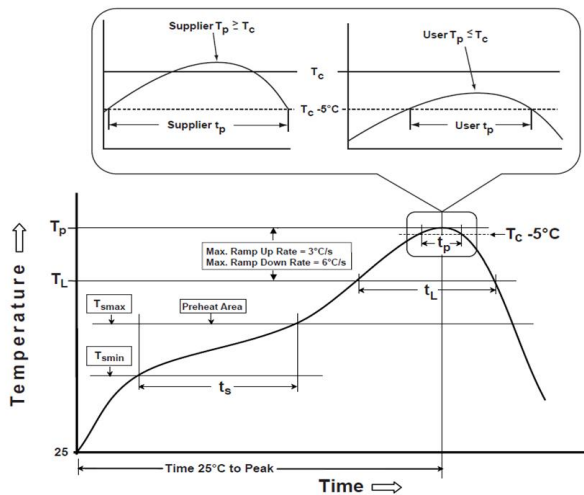

Reflow times: 3 times Max

Figure 1: IR Soldering Reflow

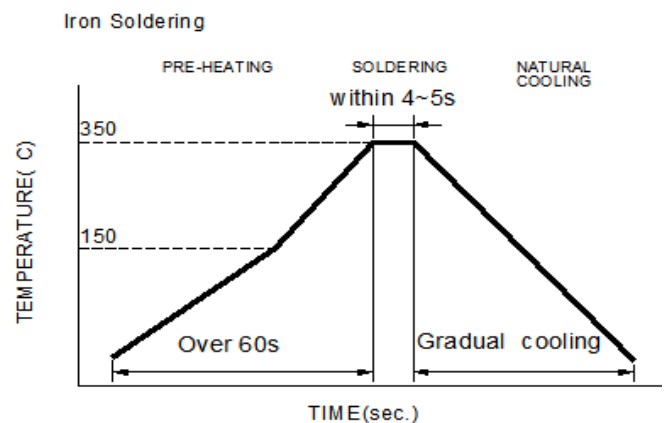

Iron Soldering times : 1 times max

Figure 2: Iron soldering temperature profiles

NOTE: Specifications subject to change without notice. Please check our website for latest information.

Table (1.1) Reflow Profiles

Profile Type:	Pb-Free Assembly
Preheat	
-Temperature Min (T_{smin})	150°C
-Temperature Max (T_{smax})	200°C
-Time (t_s) from (T_{smin} to T_{smax})	60-120seconds
Ramp-up rate (T_L to T_p)	3°C /second max.
Liquids temperature (T_L)	217°C
Time (t_L) maintained above T_L	60-150 seconds
Classification temperature (T_c)	See Table (1.2)
Time (t_p) at $T_c - 5^\circ\text{C}$ (T_p should be equal to or less than T_c .)	< 30 seconds
Ramp-down rate (T_p to T_L)	6°C /second max.
Time 25°C to peak temperature	8 minutes max.

T_p: maximum peak package body temperature, **T_c**: the classification temperature.

For user (customer) **T_p** should be equal to or less than **T_c**.

Table (1.2) Package Thickness/Volume and Classification Temperature (T_c)

	Package Thickness	Volume mm ³ <350	Volume mm ³ 350-2000	Volume mm ³ >2000
PB-Free Assembly	<1.6mm	260°C	260°C	260°C
	1.6-2.5mm	260°C	250°C	245°C
	≥2.5mm	250°C	245°C	245°C

Reflow is referred to standard IPC/JEDEC J-STD-020F.

8-3. Soldering Volume

Accordingly increasing the solder volume, the mechanical stress to product is also increased. Exceeding solder volume may cause the failure of mechanical or electrical performance. Solder shall be used not to be exceeded as shown in the Figure below.

Minimum fillet height = soldering thickness + 25% product height.

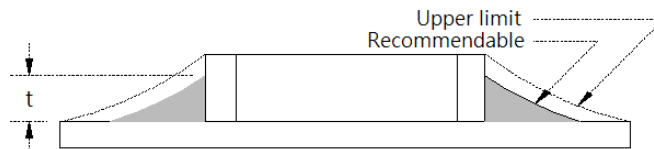

NOTE: Specifications subject to change without notice. Please check our website for latest information.

9. Packaging Information

9-1. Reel Dimension (Unit: mm)

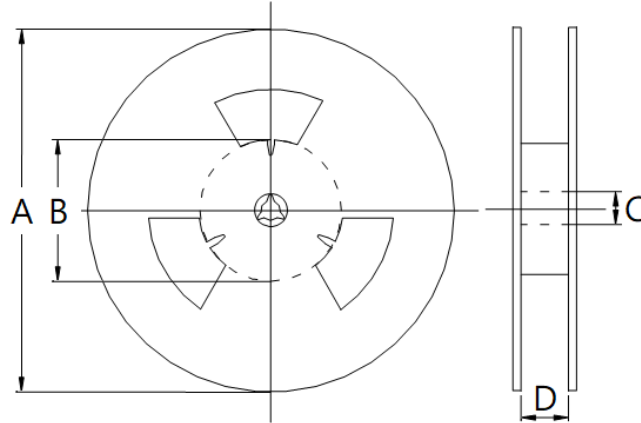

Type	A	B	C	D
13"x24mm	330.0 Ref	100.0 Ref	13.5 Ref	24.5 Ref

9-2. Tape Dimension (Unit: mm)

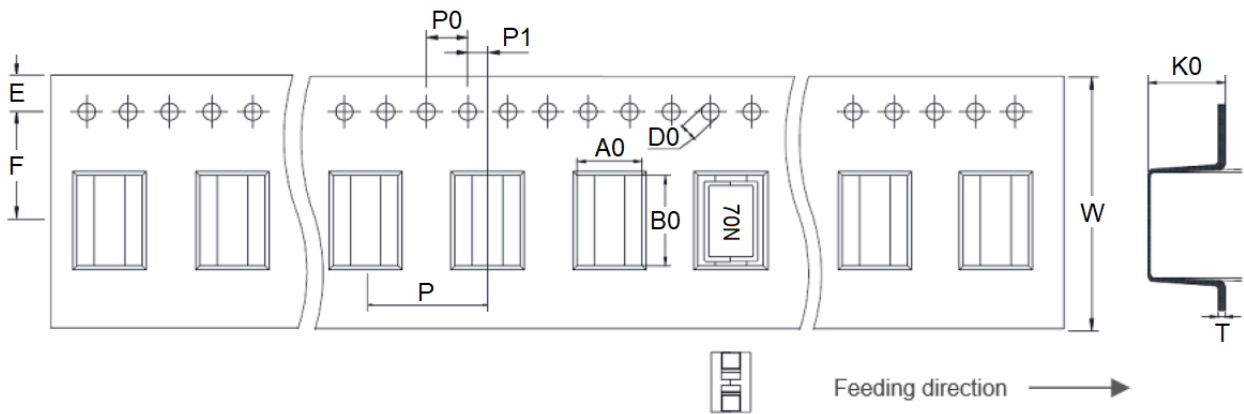

B0	A0	K0	P	P0	P1
12.20±0.10	6.20±0.10	11.30±0.10	12.00±0.10	4.00±0.10	2.00±0.10
W	F	E	D0	T	-
24.00±0.30	11.50±0.10	1.75±0.10	1.50±0.10	0.50±0.05	-

NOTE: Specifications subject to change without notice. Please check our website for latest information.

9-3. Packaging Quantity (Unit: Pcs)

Chip/ Reel	400
------------	-----

9-4. Tearing Off Force

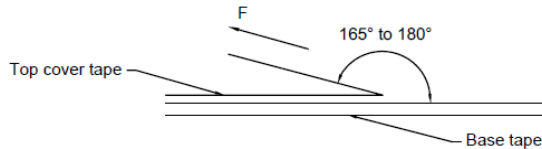

The force for tearing off cover tape is according to the follow table, in the arrow direction under the following conditions.

(Referenced ANSI/EIA-481-D-2008 of 4.11 standard)

Room Temp. (°C)	Room Humidity (%)	Room atm (hPa)	Tearing Speed (mm/min)
5~35	45~85	860~1060	300±10

Tape Size	8 mm	12 to 56 mm	72 mm or Wider
Tearing Off Force (grams)	10~100	10~130	10~150

Application Notice

1. Storage Conditions

To maintain the solderability of terminal electrodes:

- (a) Products meet IPC/JEDEC J-STD-020F standard-MSL, level 1.
- (b) Recommended products should be used within 12 months from the time of delivery.
- (c) The packaging material should be kept where no chlorine or sulfur exists in the air.

2. Transportation

- (a) Products should be handled with care to avoid damage or contamination from perspiration and skin oils.
- (b) Vacuum pick up is strongly recommended for individual components.
- (c) Bulk handling should ensure that abrasion and mechanical shock are minimized.

NOTE: Specifications subject to change without notice. Please check our website for latest information.