

## 1. Part No. Expression

**SPS 201609 N R 33 M**

(a)        (b)        (c)    (d)    (e)

- (a) Series Code
- (b) Dimension Code
- (c) Material Code
- (d) Inductance Code
- (e) Tolerance Code

## 2. Configuration & Dimensions (Unit: mm)

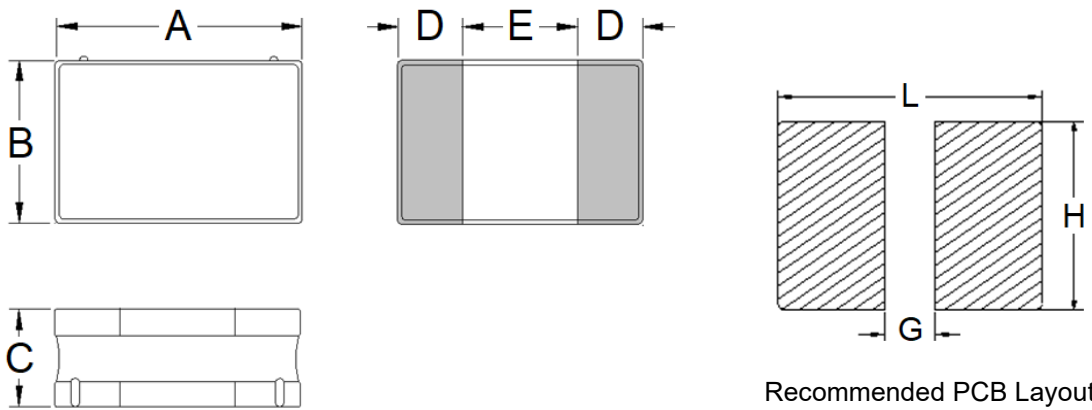

Note: The above PCB layout reference only.

A	B	C	D
2.00+0.20/-0.10	1.60+0.20/-0.10	0.95 Max	0.60 Ref
E	L	G	H
0.80 Ref	2.30 Ref	0.70 Ref	1.70 Ref

NOTE: Specifications subject to change without notice. Please check our website for latest information.

### 3. Material List

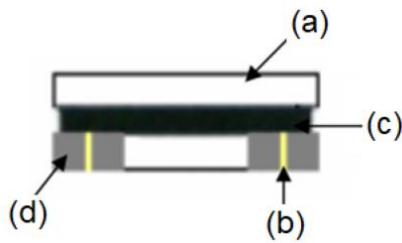

- (a) Core
- (b) Wire
- (c) Glue
- (d) Terminal

Void appearance tolerance limit & size of voids occurring to coating resin is specified below.

Exposed wire tolerance limit of coating resin part on product side.

Size of exposed wire occurring to coating resin is specified below:

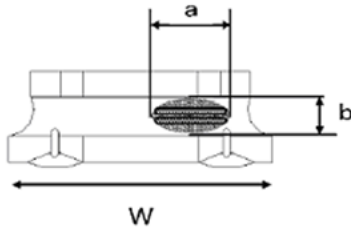

1. Width direction (dimension a) : Acceptable when  $a \leq w/2$ ;

Nonconforming when  $a > w/2$

2. Length direction (dimension b): Dimension b is not specified

3. The total area of exposed wire occurring to each side is not greater than 50% of coating resin area and is acceptable

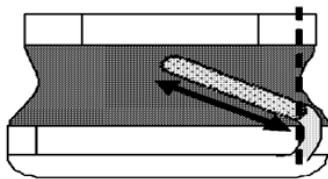

External appearance criterion for exposed wire.

Exposed end of the winding wire at the secondary side should be 2mm and below.

### 4. General Specifications

- (a) Operating Temp.: -40°C to +125°C (including self-temperature rise)
- (b) Storage Temp.: -40°C to +125°C (on board)
- (c) All test data referenced to 25°C ambient.
- (d) Heat Rated Current (I<sub>rms</sub>) will cause the coil temperature rise approximately  $\Delta T$  of 40°C.
- (e) Saturation Current (I<sub>sat</sub>) will cause inductance L<sub>0</sub> to drop approximately 30%.
- (f) Storage Condition (Component in its packaging)
  - i) Temperature: Less than 40°C
  - ii) Humidity: Less than 60% RH

**NOTE:** Specifications subject to change without notice. Please check our website for latest information.

## 5. Electrical Characteristics

Part Number	Inductance ( $\mu$ H) @0A $\pm 20\%$	Test Frequency	I <sub>rms</sub> (A)		I <sub>sat</sub> (A)		DCR ( $\Omega$ ) $\pm 20\%$
			Typ	Max	Typ	Max	
SPS201609NR33M	0.33	0.1V/1MHz	2.40	2.10	2.40	2.10	0.028
SPS201609NR47M	0.47	0.1V/1MHz	2.30	2.00	2.30	2.00	0.038
SPS201609NR68M	0.68	0.1V/1MHz	1.80	1.50	1.80	1.50	0.055
SPS201609N1R0M	1.0	0.1V/1MHz	1.70	1.40	1.70	1.40	0.065
SPS201609N1R5M	1.5	0.1V/1MHz	1.40	1.20	1.40	1.20	0.110
SPS201609N2R2M	2.2	0.1V/1MHz	1.10	0.90	1.10	0.90	0.160
SPS201609N3R3M	3.3	0.1V/1MHz	1.00	0.85	1.00	0.85	0.250
SPS201609N4R7M	4.7	0.1V/1MHz	0.90	0.75	0.90	0.75	0.400
SPS201609N6R8M	6.8	0.1V/1MHz	0.75	0.65	0.75	0.65	0.550
SPS201609N100M	10	0.1V/1MHz	0.60	0.55	0.70	0.60	1.00

NOTE: Specifications subject to change without notice. Please check our website for latest information.

6. Characteristics Curve

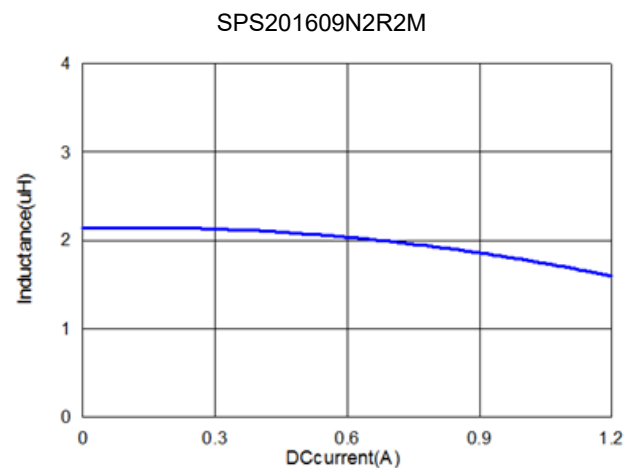
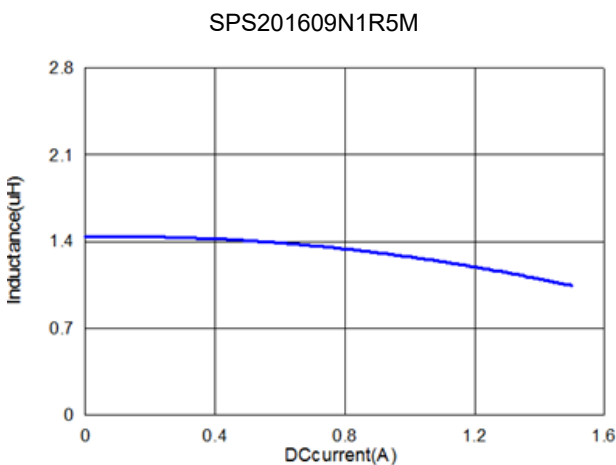
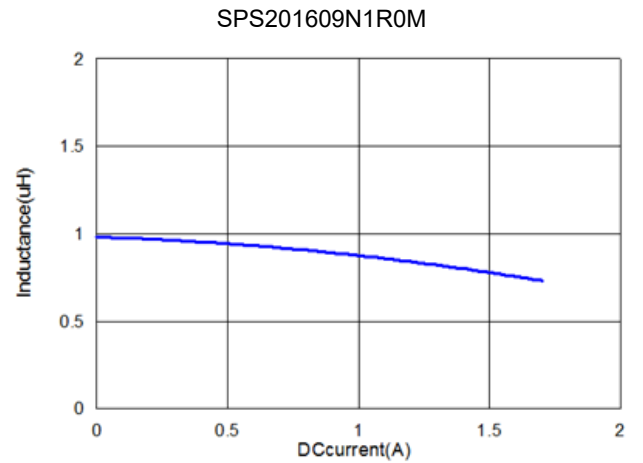
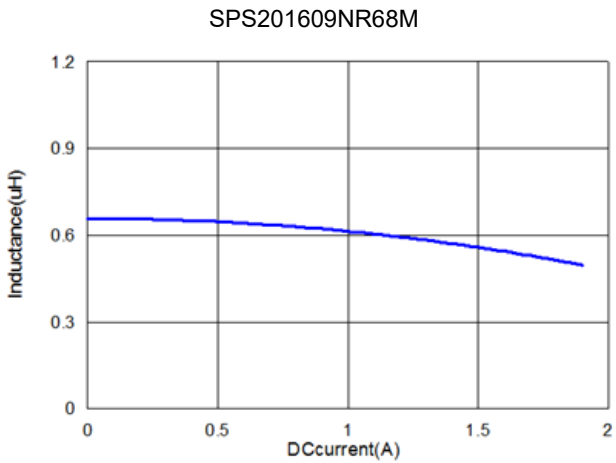
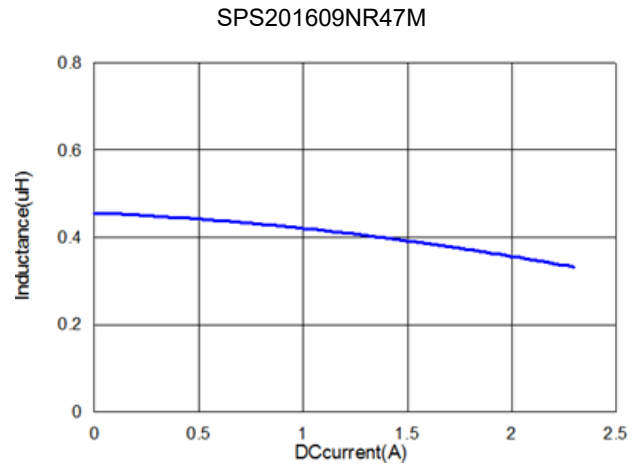
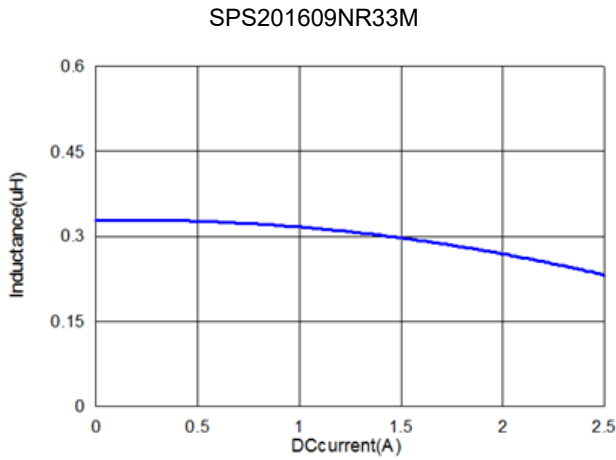

NOTE: Specifications subject to change without notice. Please check our website for latest information.

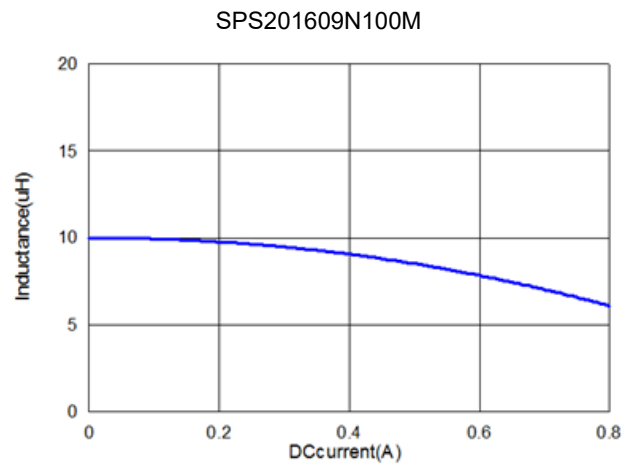
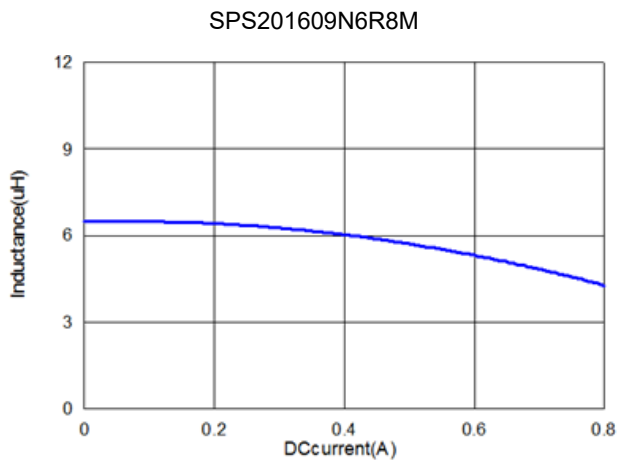
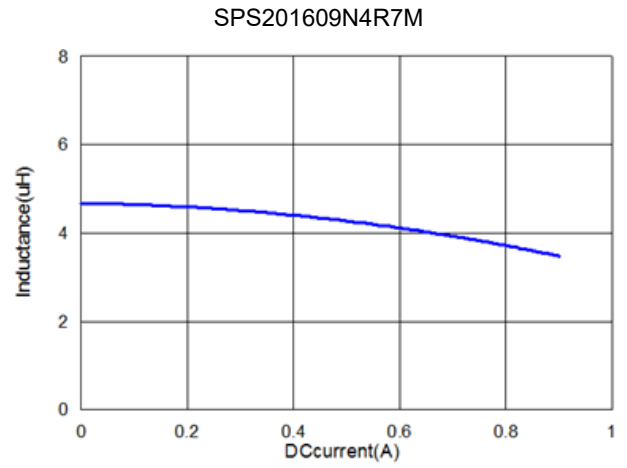
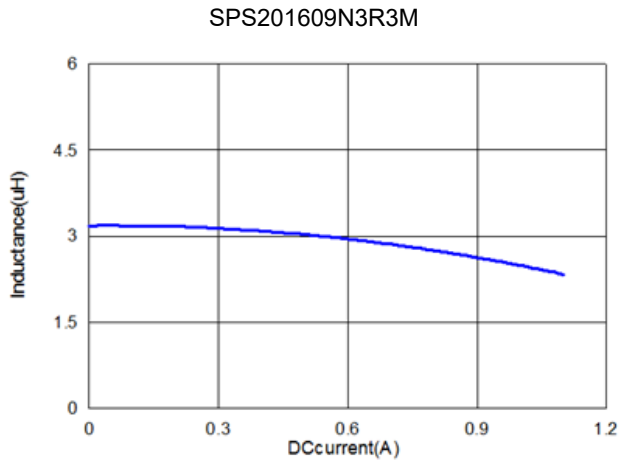

NOTE: Specifications subject to change without notice. Please check our website for latest information.

### 7. Soldering Specification

Mildly activated rosin fluxes are preferred. Our terminations are suitable for re-flow soldering systems. If hand soldering cannot be avoided, the preferred technique is the utilization of hot air soldering tools.

#### 7-1. IR Soldering Reflow

Recommended temperature profiles for lead free re-flow soldering in Figure 1, Table 1.1 & 1.2 (J-STD-020F).

#### 7-2. Iron Reflow

Products attachment with a soldering iron is discouraged due to the inherent process control limitations. In the event that a soldering iron must be employed the following precautions are recommended (Figure 2).

Note:

- (a) Preheat circuit and products to 150°C.
- (b) 350°C tip temperature (Max.)
- (c) Never contact the ceramic with the iron tip
- (d) 1.0mm tip diameter (Max.)
- (e) Use a 20 watt soldering iron with tip diameter of 1.0mm
- (f) Limit soldering time to 4~5 sec.

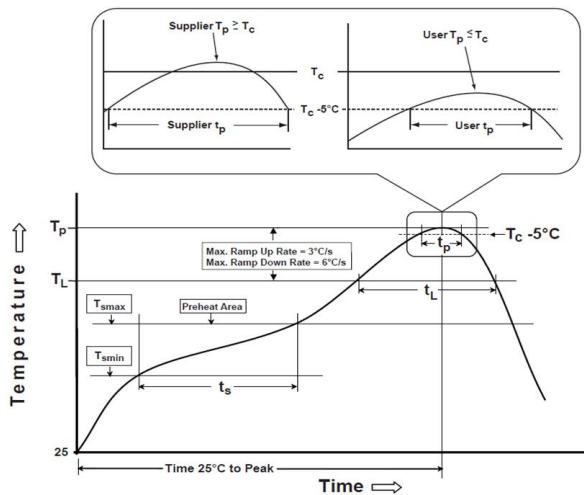

Reflow times: 3 times Max

Figure 1: IR Soldering Reflow

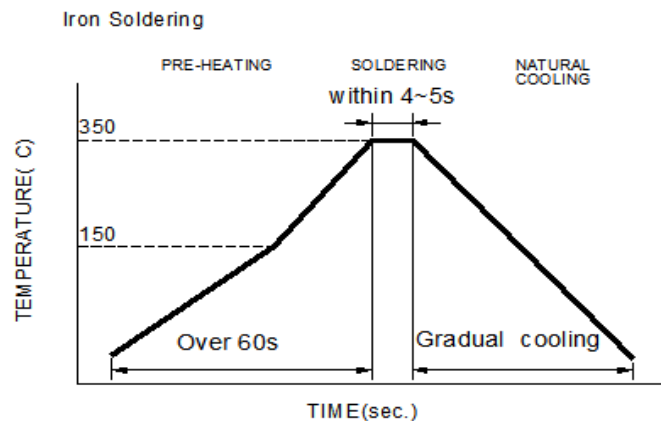

Iron Soldering times : 1 times max

Figure 2: Iron soldering temperature profiles

NOTE: Specifications subject to change without notice. Please check our website for latest information.

**Table (1.1) Reflow Profiles**

Profile Type:	Pb-Free Assembly
Preheat	
-Temperature Min ( $T_{smin}$ )	150°C
-Temperature Max ( $T_{smax}$ )	200°C
-Time ( $t_s$ ) from ( $T_{smin}$ to $T_{smax}$ )	60-120seconds
Ramp-up rate ( $T_L$ to $T_p$ )	3°C /second max.
Liquids temperature ( $T_L$ )	217°C
Time ( $t_L$ ) maintained above $T_L$	60-150 seconds
Classification temperature ( $T_c$ )	See Table (1.2)
Time ( $t_p$ ) at $T_c - 5^\circ\text{C}$ ( $T_p$ should be equal to or less than $T_c$ .)	< 30 seconds
Ramp-down rate ( $T_p$ to $T_L$ )	6°C /second max.
Time 25°C to peak temperature	8 minutes max.

**T<sub>p</sub>**: maximum peak package body temperature, **T<sub>c</sub>**: the classification temperature.

For user (customer) **T<sub>p</sub>** should be equal to or less than **T<sub>c</sub>**.

**Table (1.2) Package Thickness/Volume and Classification Temperature ( $T_c$ )**

	Package Thickness	Volume mm <sup>3</sup> <350	Volume mm <sup>3</sup> 350-2000	Volume mm <sup>3</sup> >2000
PB-Free Assembly	<1.6mm	260°C	260°C	260°C
	1.6-2.5mm	260°C	250°C	245°C
	≥2.5mm	250°C	245°C	245°C

Reflow is referred to standard IPC/JEDEC J-STD-020F.

### 7-3. Soldering Volume

Accordingly increasing the solder volume, the mechanical stress to product is also increased. Exceeding solder volume may cause the failure of mechanical or electrical performance. Solder shall be used not to be exceeded as shown in the Figure below.

Minimum fillet height = soldering thickness + 25% product height.



NOTE: Specifications subject to change without notice. Please check our website for latest information.

8. Packaging Information

8-1. Reel Dimension (Unit: mm)

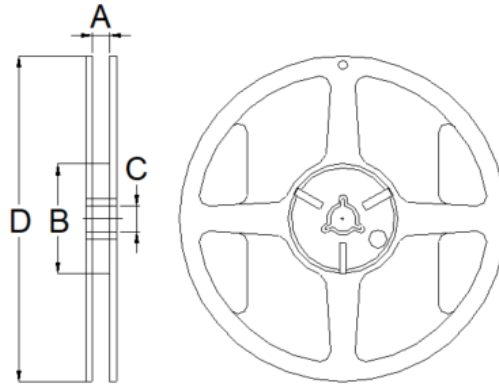

Type	A	B	C	D
7"X8mm	8.4 Ref	50.0 Min	13.0 Ref	178.0 Ref

8-2. Tape Dimension (Unit: mm)

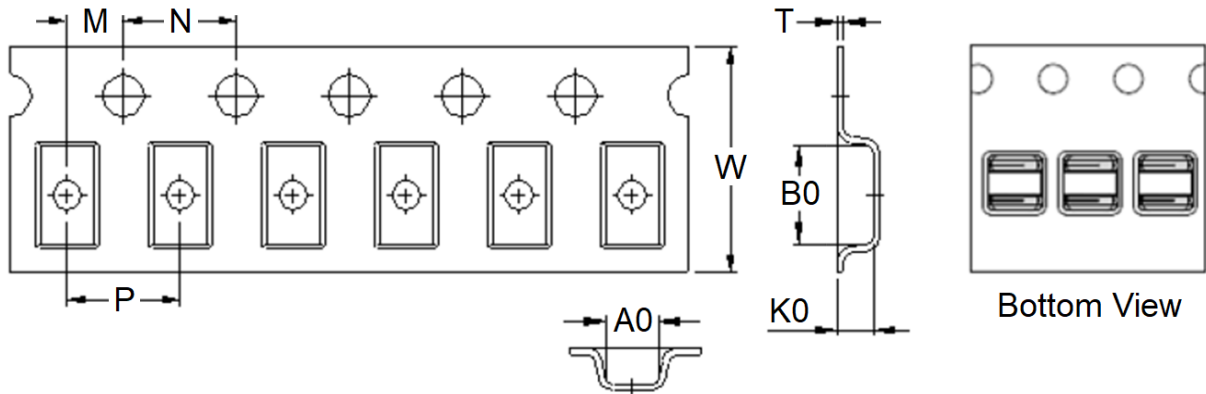

B0	A0	K0	P	T	M	N	W
2.50±0.10	2.00±0.10	1.20±0.10	4.00±0.10	0.22±0.05	2.00±0.05	4.00±0.10	8.00±0.10

NOTE: Specifications subject to change without notice. Please check our website for latest information.

### 8-3. Packaging Quantity (Unit: Pcs)

Chip/ Reel	2,000
------------	-------

### 8-4. Tearing Off Force

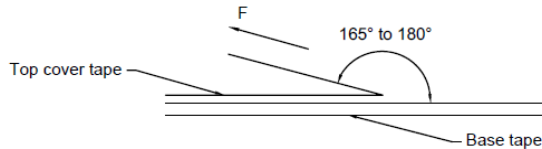

The force for tearing off cover tape is according to the follow table, in the arrow direction under the following conditions.

(Referenced ANSI/EIA-481-D-2008 of 4.11 standard)

Room Temp. (°C)	Room Humidity (%)	Room atm (hPa)	Tearing Speed (mm/min)
5~35	45~85	860~1060	300±10

Tape Size	8 mm	12 to 56 mm	72 mm or Wider
Tearing Off Force (grams)	10~100	10~130	10~150

## Application Notice

### 1. Storage Conditions

To maintain the solderability of terminal electrodes:

- (a) Products meet IPC/JEDEC J-STD-020F standard-MSL, level 1.
- (b) Recommended products should be used within 12 months from the time of delivery.
- (c) The packaging material should be kept where no chlorine or sulfur exists in the air.

### 2. Transportation

- (a) Products should be handled with care to avoid damage or contamination from perspiration and skin oils.
- (b) Vacuum pick up is strongly recommended for individual components.
- (c) Bulk handling should ensure that abrasion and mechanical shock are minimized.

**NOTE:** Specifications subject to change without notice. Please check our website for latest information.