

1. Part No. Expression

PDC05041R0MZF

(a) (b) (c) (d) (e) (f)

- | | |
|---------------------|--------------------|
| (a) Series Code | (d) Tolerance Code |
| (b) Dimension Code | (e) Special Code |
| (c) Inductance Code | (f) Packaging Code |

2. Configuration & Dimensions (Unit: mm)

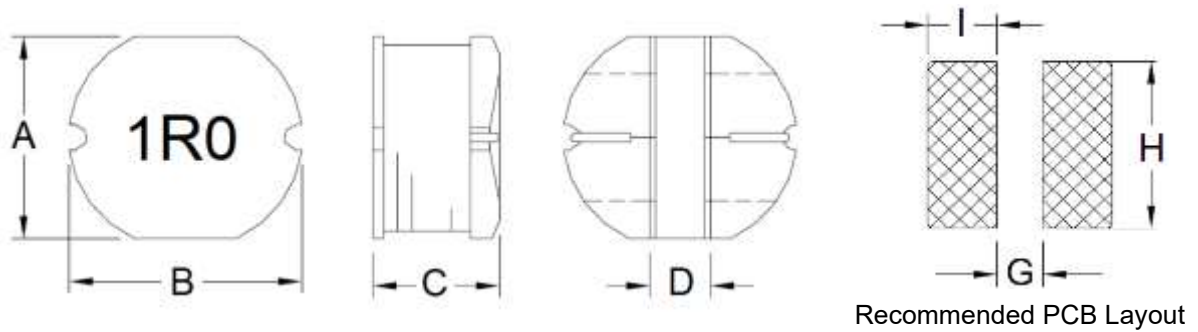

- Note:
1. The above PCB layout reference only.
 2. Marking: Inductance Code, Black

A	B	C	D	G	H	I
5.20±0.30	5.80±0.30	4.50±0.35	2.00±0.30	1.70 Ref	5.50 Ref	2.15 Ref

NOTE: Specifications subject to change without notice. Please check our website for latest information.

3. Schematic

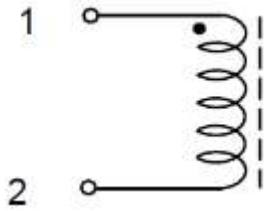

4. Material List

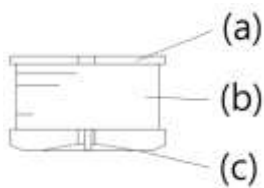

- (a) Core
- (b) Wire
- (c) Electrode

5. General Specifications

- (a) Operating Temp.: -40°C to +125°C (including self-temperature rise)
- (b) Storage Temp.: -40°C to +125°C (on board)
- (c) All test data referenced to 25°C ambient.
- (d) IDC will cause the coil temperature rise approximately ΔT of 40°C Max, and inductance L_0 to drop approximately 10%.
- (e) Rated Current: The lower value of I_{sat} and I_{rms} .
- (f) Storage Condition (Component in its packaging)
 - i) Temperature: 25°C \pm 5°C
 - ii) Humidity: 35~70% RH

NOTE: Specifications subject to change without notice. Please check our website for latest information.

6. Electrical Characteristics

Part Number	Inductance (μ H) @0A	Test Frequency	DCR (Ω) Max	IDC (A)	
				Typ	Max
PDC05041R0MZF	1.0 \pm 20%	1V/7.96MHz	0.015	5.90	4.75
PDC05041R2MZF	1.2 \pm 20%	1V/7.96MHz	0.020	5.20	4.20
PDC05041R5MZF	1.5 \pm 20%	1V/7.96MHz	0.025	4.70	3.80
PDC05041R8MZF	1.8 \pm 20%	1V/7.96MHz	0.030	4.00	3.20
PDC05042R2MZF	2.2 \pm 20%	1V/7.96MHz	0.035	3.80	3.10
PDC05042R7MZF	2.7 \pm 20%	1V/7.96MHz	0.040	3.40	2.75
PDC05043R3MZF	3.3 \pm 20%	1V/7.96MHz	0.045	3.30	2.65
PDC05043R9MZF	3.9 \pm 20%	1V/7.96MHz	0.050	2.90	2.35
PDC05044R7MZF	4.7 \pm 20%	1V/7.96MHz	0.060	2.80	2.50
PDC05045R6MZF	5.6 \pm 20%	1V/7.96MHz	0.070	2.40	1.95
PDC05046R8MZF	6.8 \pm 20%	1V/7.96MHz	0.080	2.10	1.70
PDC05048R2MZF	8.2 \pm 20%	1V/7.96MHz	0.090	2.00	1.60
PDC0504100MZF	10.0 \pm 20%	1V/2.52MHz	0.100	1.44	1.15
PDC0504120MZF	12.0 \pm 20%	1V/2.52MHz	0.120	1.40	1.12
PDC0504150MZF	15.0 \pm 20%	1V/2.52MHz	0.140	1.30	1.05
PDC0504180MZF	18.0 \pm 20%	1V/2.52MHz	0.150	1.23	1.00
PDC0504220MZF	22.0 \pm 20%	1V/2.52MHz	0.180	1.11	0.90
PDC0504270MZF	27.0 \pm 20%	1V/2.52MHz	0.200	0.97	0.78
PDC0504330KZF	33.0 \pm 10%	1V/2.52MHz	0.230	0.88	0.70
PDC0504390KZF	39.0 \pm 10%	1V/2.52MHz	0.320	0.80	0.65
PDC0504470KZF	47.0 \pm 10%	1V/2.52MHz	0.370	0.72	0.60
PDC0504560KZF	56.0 \pm 10%	1V/2.52MHz	0.420	0.68	0.55
PDC0504680KZF	68.0 \pm 10%	1V/2.52MHz	0.460	0.61	0.50
PDC0504820KZF	82.0 \pm 10%	1V/2.52MHz	0.600	0.58	0.47
PDC0504101KZF	100.0 \pm 10%	1V/1kHz	0.700	0.52	0.42
PDC0504121KZF	120.0 \pm 10%	1V/1kHz	0.930	0.48	0.40
PDC0504151KZF	150.0 \pm 10%	1V/1kHz	1.100	0.40	0.32
PDC0504181KZF	180.0 \pm 10%	1V/1kHz	1.380	0.38	0.30
PDC0504221KZF	220.0 \pm 10%	1V/1kHz	1.570	0.35	0.28
PDC0504102KZF	1000.0 \pm 10%	1V/1kHz	6.000	0.15	0.12

NOTE: Specifications subject to change without notice. Please check our website for latest information.

7. Soldering Specification

Mildly activated rosin fluxes are preferred. Our terminations are suitable for re-flow soldering systems. If hand soldering cannot be avoided, the preferred technique is the utilization of hot air soldering tools.

7-1. IR Soldering Reflow

Recommended temperature profiles for lead free re-flow soldering in Figure 1, Table 1.1 & 1.2 (J-STD-020F).

7-2. Iron Reflow

Products attachment with a soldering iron is discouraged due to the inherent process control limitations. In the event that a soldering iron must be employed the following precautions are recommended (Figure 2).

Note:

- (a) Preheat circuit and products to 150°C.
- (b) 350°C tip temperature (Max.)
- (c) Never contact the ceramic with the iron tip
- (d) 1.0mm tip diameter (Max.)
- (e) Use a 20 watt soldering iron with tip diameter of 1.0mm
- (f) Limit soldering time to 4~5 sec.

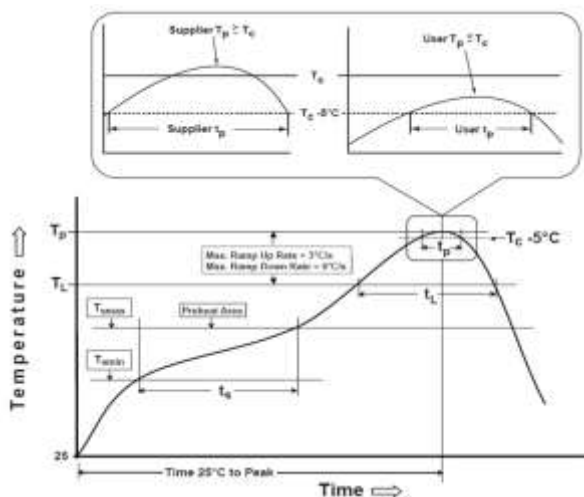

Reflow times: 3 times Max

Figure 1: IR Soldering Reflow

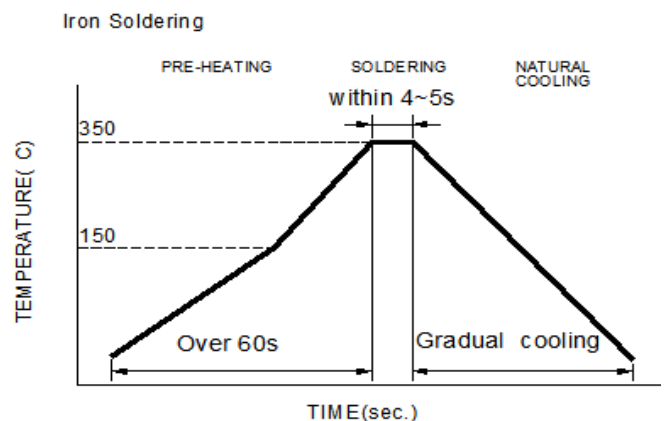

Iron Soldering times : 1 times max

Figure 2: Iron soldering temperature profiles

NOTE: Specifications subject to change without notice. Please check our website for latest information.

Table (1.1) Reflow Profiles

Profile Type:	Pb-Free Assembly
Preheat	
-Temperature Min (T_{smin})	150°C
-Temperature Max (T_{smax})	200°C
-Time (t_s) from (T_{smin} to T_{smax})	60-120seconds
Ramp-up rate (T_L to T_p)	3°C /second max.
Liquids temperature (T_L)	217°C
Time (t_L) maintained above T_L	60-150 seconds
Classification temperature (T_c)	See Table (1.2)
Time (t_p) at $T_c - 5^\circ\text{C}$ (T_p should be equal to or less than T_c .)	< 30 seconds
Ramp-down rate (T_p to T_L)	6°C /second max.
Time 25°C to peak temperature	8 minutes max.

T_p: maximum peak package body temperature, **T_c**: the classification temperature.

For user (customer) **T_p** should be equal to or less than **T_c**.

Table (1.2) Package Thickness/Volume and Classification Temperature (T_c)

	Package Thickness	Volume mm ³ <350	Volume mm ³ 350-2000	Volume mm ³ >2000
PB-Free Assembly	<1.6mm	260°C	260°C	260°C
	1.6-2.5mm	260°C	250°C	245°C
	≥2.5mm	250°C	245°C	245°C

Reflow is referred to standard IPC/JEDEC J-STD-020F.

7-3. Soldering Volume

Accordingly increasing the solder volume, the mechanical stress to product is also increased. Exceeding solder volume may cause the failure of mechanical or electrical performance. Solder shall be used not to be exceeded as shown in the Figure below.

Minimum fillet height = soldering thickness + 25% product height.



NOTE: Specifications subject to change without notice. Please check our website for latest information.

8. Packaging Information

8-1. Reel Dimension (Unit: mm)

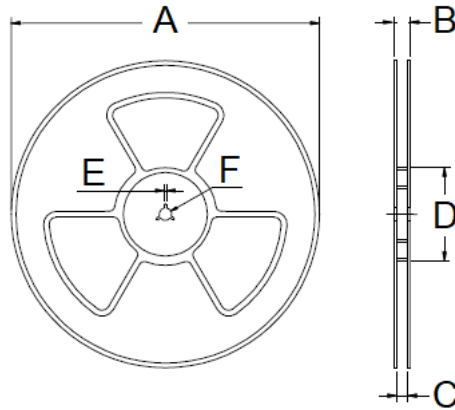

Type	A	B	C	D	E	F
13"x12mm	330.00 Ref	18.40 Ref	12.40 Ref	100.00 Ref	2.30 Ref	R6.75

8-2. Tape Dimension (Unit: mm)

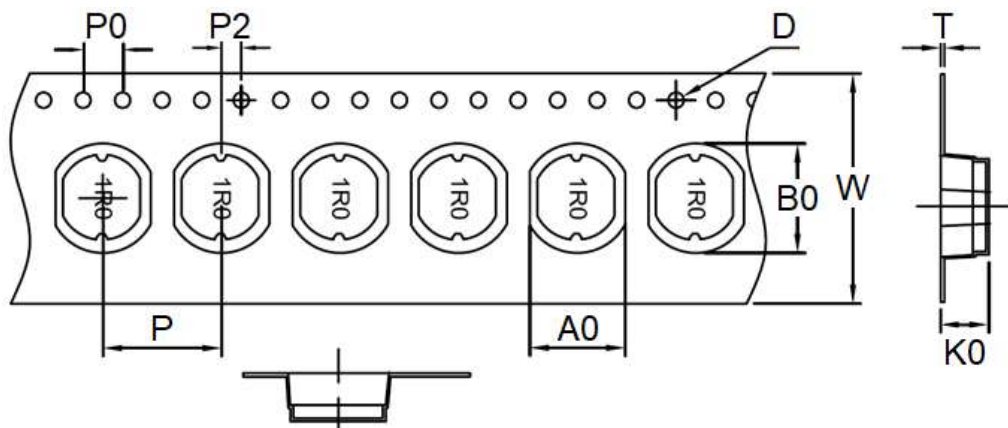

W	A0	B0	K0	P
12.0+0.3/-0.1	5.5±0.1	6.0±0.1	4.7±0.1	8.0±0.1
D	P0	P2	T	-
1.5+0.1/-0.0	4.0±0.1	2.0±0.1	0.4 Ref	-

NOTE: Specifications subject to change without notice. Please check our website for latest information.

8-3. Packaging Quantity (Unit: Pcs)

Chip/ Reel	1,500
Inner Box	3,000
Outer Box	15,000

8-4. Tearing Off Force

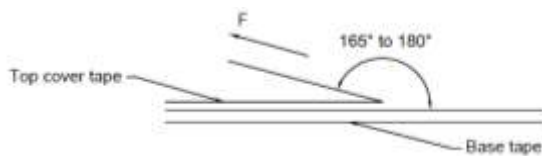

The force for tearing off cover tape is according to the follow table, in the arrow direction under the following conditions.

(Referenced ANSI/EIA-481-D-2008 of 4.11 standard)

Room Temp. (°C)	Room Humidity (%)	Room atm (hPa)	Tearing Speed (mm/min)
5~35	45~85	860~1060	300±10

Tape Size	8 mm	12 to 56 mm	72 mm or Wider
Tearing Off Force (grams)	10~100	10~130	10~150

Application Notice

1. Storage Conditions

To maintain the solderability of terminal electrodes:

- (a) Products meet IPC/JEDEC J-STD-020F standard-MSL, level 1.
- (b) Recommended products should be used within 6 months from the time of delivery.
- (c) The packaging material should be kept where no chlorine or sulfur exists in the air.

2. Transportation

- (a) Products should be handled with care to avoid damage or contamination from perspiration and skin oils.
- (b) Vacuum pick up is strongly recommended for individual components.
- (c) Bulk handling should ensure that abrasion and mechanical shock are minimized.

NOTE: Specifications subject to change without notice. Please check our website for latest information.