

1. Part No. Expression

SSB06021R0MZF

(a) (b) (c) (d) (e) (f)

- | | |
|---------------------|--------------------|
| (a) Series Code | (d) Tolerance Code |
| (b) Dimension Code | (e) Special Code |
| (c) Inductance Code | (f) Packaging Code |

2. Configuration & Dimensions (Unit: mm)

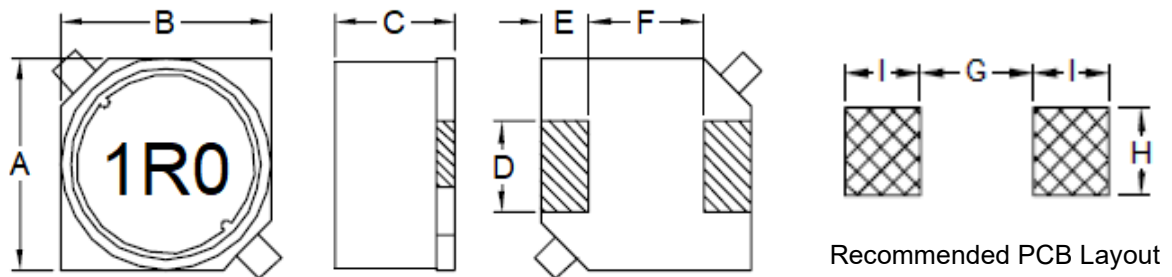

Note: The above PCB layout reference only.

A	B	C	D	E
6.0±0.3	6.0±0.3	2.5 Max	2.0±0.2	1.5±0.2
F	G	H	I	-
3.0±0.2	2.8 Ref	2.2 Ref	1.9 Ref	-

NOTE: Specifications subject to change without notice. Please check our website for latest information.

3. Schematic

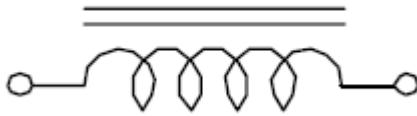

4. Material List

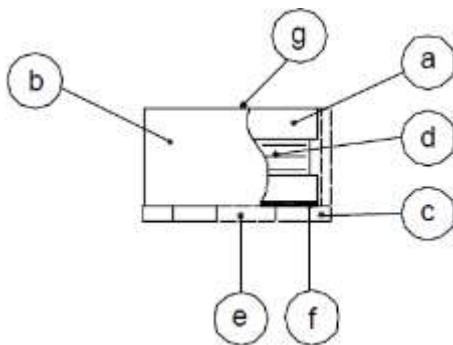

- (a) DR Core
- (b) RI Core
- (c) Base
- (d) Wire
- (e) Terminal
- (f) Adhesive
- (g) Ink

5. General Specifications

- (a) Operating Temp.: -40°C to +85°C (including self-temperature rise)
- (b) All test data referenced to 25°C ambient.
- (c) Heat Rated Current (I_{rms}) will cause the coil temperature rise ΔT of 40°C Max.
- (d) Saturation Current (I_{sat}) will cause inductance L₀ to drop 10% Max.
- (e) Rated Current: The lower value of I_{sat} and I_{rms}.
- (f) Resistance to Solder Heat: 260°C, 10Sec.
- (g) Storage Condition (Component in its packaging)
 - i) Temperature: -10°C to 40°C
 - ii) Humidity: Less than 60% RH

NOTE: Specifications subject to change without notice. Please check our website for latest information.

6. Electrical Characteristics

Part Number	Inductance (uH) ±20%	Test Frequency	RDC (mΩ) Max	IDC (A) Max
SSB06021R0MZF	1.0	1V/100KHz	30	2.50
SSB06021R5MZF	1.5	1V/100KHz	35	2.30
SSB06022R2MZF	2.2	1V/100KHz	45	2.00
SSB06023R3MZF	3.3	1V/100KHz	70	1.60
SSB06024R7MZF	4.7	1V/100KHz	85	1.35
SSB06026R8MZF	6.8	1V/100KHz	120	1.10
SSB0602100MZF	10.0	1V/100KHz	170	0.95
SSB0602150MZF	15.0	1V/100KHz	240	0.75
SSB0602220MZF	22.0	1V/100KHz	330	0.65
SSB0602330MZF	33.0	1V/100KHz	480	0.50
SSB0602470MZF	47.0	1V/100KHz	650	0.40
SSB0602680MZF	68.0	1V/100KHz	870	0.30
SSB0602101MZF	100.0	1V/100KHz	1500	0.25
SSB0602151MZF	150.0	1V/100KHz	2300	0.20
SSB0602221MZF	220.0	1V/100KHz	3200	0.18
SSB0602331MZF	330.0	1V/100KHz	4800	0.16
SSB0602471MZF	470.0	1V/100KHz	7200	0.13
SSB0602681MZF	680.0	1V/100KHz	10000	0.11
SSB0602102MZF	1000.0	1V/100KHz	15500	0.09

NOTE: Specifications subject to change without notice. Please check our website for latest information.

7. Characteristics Curves

@ TEMP. RISE VS. DC SUPERPOSITION RESPONSE CURVE

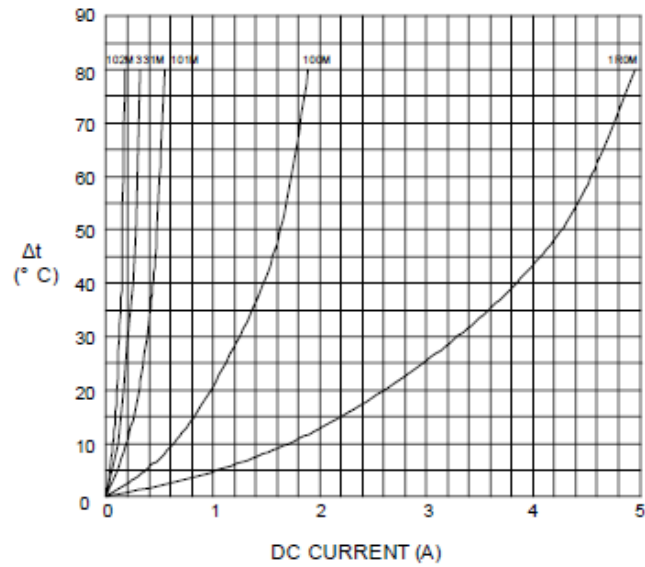

@ INDUCTANCE VS. FREQUENCY RESPONSE CURVE

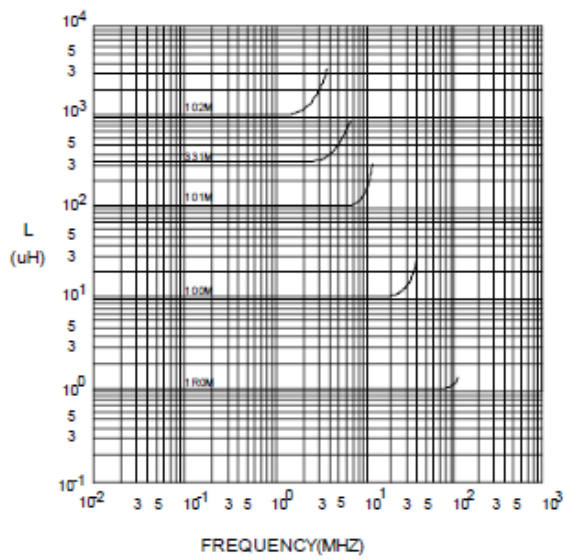

@ INDUCTANCE VS. DC SUPERPOSITION RESPONSE CURVE

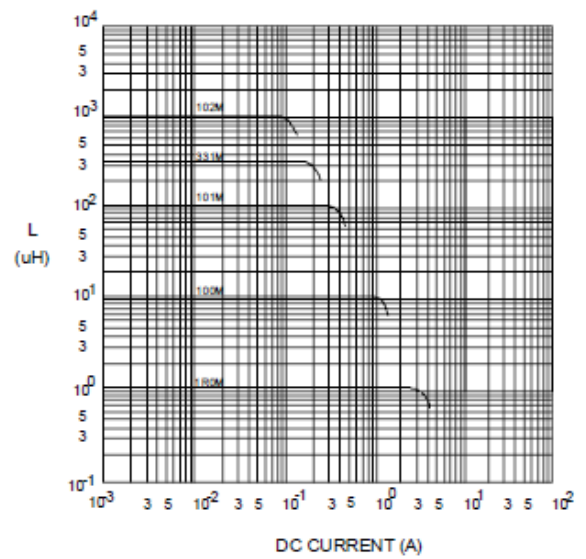

NOTE: Specifications subject to change without notice. Please check our website for latest information.

8. Soldering Specification

Mildly activated rosin fluxes are preferred. Our terminations are suitable for re-flow soldering systems. If hand soldering cannot be avoided, the preferred technique is the utilization of hot air soldering tools.

8-1. IR Soldering Reflow

Recommended temperature profiles for lead free re-flow soldering in Figure 1, Table 1.1 & 1.2 (J-STD-020F).

8-2. Iron Reflow

Products attachment with a soldering iron is discouraged due to the inherent process control limitations. In the event that a soldering iron must be employed the following precautions are recommended (Figure 2).

Note:

- (a) Preheat circuit and products to 150°C.
- (b) 350°C tip temperature (Max.)
- (c) Never contact the ceramic with the iron tip
- (d) 1.0mm tip diameter (Max.)
- (e) Use a 20 watt soldering iron with tip diameter of 1.0mm
- (f) Limit soldering time to 4~5 sec.

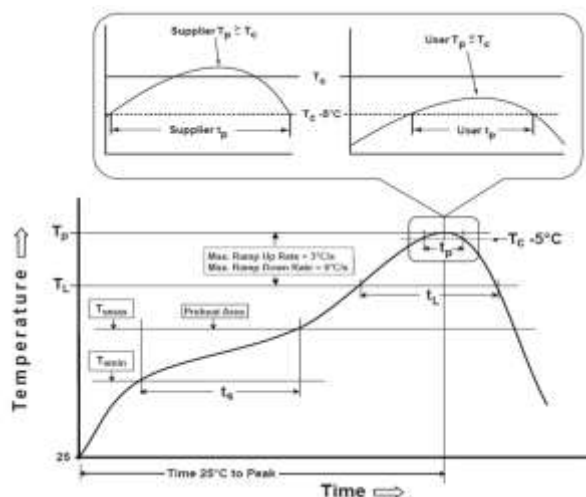

Reflow times: 3 times Max

Figure 1: IR Soldering Reflow

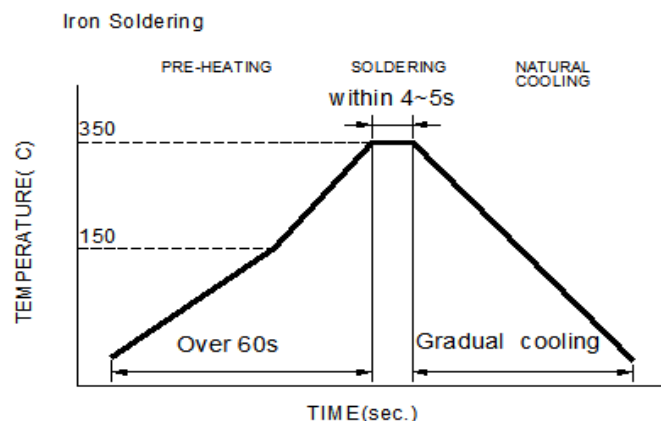

Iron Soldering times : 1 times max

Figure 2: Iron soldering temperature profiles

NOTE: Specifications subject to change without notice. Please check our website for latest information.

Table (1.1) Reflow Profiles

Profile Type:	Pb-Free Assembly
Preheat	
-Temperature Min (T_{smin})	150°C
-Temperature Max (T_{smax})	200°C
-Time (t_s) from (T_{smin} to T_{smax})	60-120seconds
Ramp-up rate (T_L to T_p)	3°C /second max.
Liquids temperature (T_L)	217°C
Time (t_L) maintained above T_L	60-150 seconds
Classification temperature (T_c)	See Table (1.2)
Time (t_p) at $T_c - 5^\circ\text{C}$ (T_p should be equal to or less than T_c .)	< 30 seconds
Ramp-down rate (T_p to T_L)	6°C /second max.
Time 25°C to peak temperature	8 minutes max.

T_p: maximum peak package body temperature, **T_c**: the classification temperature.

For user (customer) **T_p** should be equal to or less than **T_c**.

Table (1.2) Package Thickness/Volume and Classification Temperature (T_c)

	Package Thickness	Volume mm ³ <350	Volume mm ³ 350-2000	Volume mm ³ >2000
PB-Free Assembly	<1.6mm	260°C	260°C	260°C
	1.6-2.5mm	260°C	250°C	245°C
	≥2.5mm	250°C	245°C	245°C

Reflow is referred to standard IPC/JEDEC J-STD-020F.

8-3. Soldering Volume

Accordingly increasing the solder volume, the mechanical stress to product is also increased. Exceeding solder volume may cause the failure of mechanical or electrical performance. Solder shall be used not to be exceeded as shown in the Figure below.

Minimum fillet height = soldering thickness + 25% product height.



NOTE: Specifications subject to change without notice. Please check our website for latest information.

9. Packaging Information

9-1. Reel Dimension (Unit: mm)

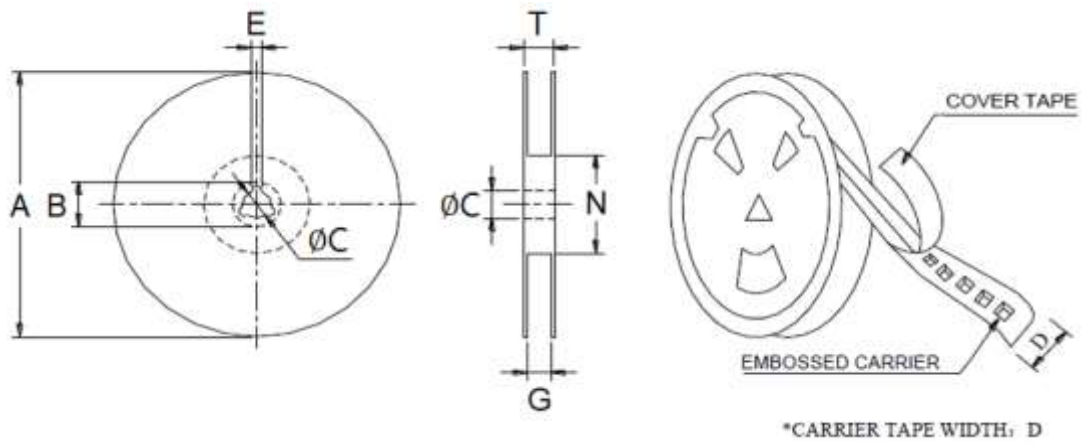

Type	A	B	C	D	G	N	T
13"x16mm	330.0 Ref	21.0 Ref	13.0 Ref	16.0 Ref	18.0 Max	50.0 Min	22.4 Ref

9-2. Tape Dimension (Unit: mm)

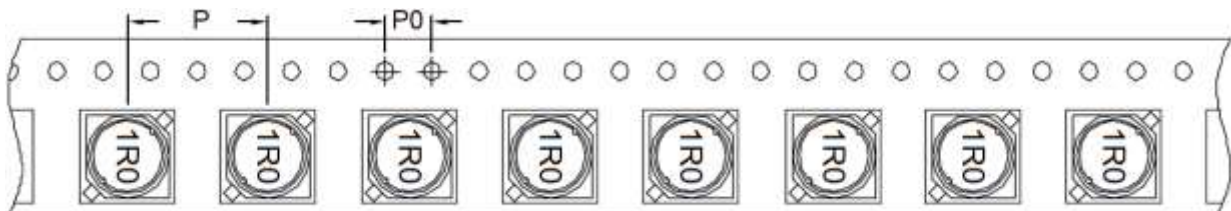

P	P0
12	4

NOTE: Specifications subject to change without notice. Please check our website for latest information.

9-3. Packaging Quantity (Unit: Pcs)

Inner: Reel			Outer: Carton		
Qty (pcs)	G.W (gw)	Style	Qty (pcs)	G.W (kg)	Size (cm)
1,500	720	13-16	9,000	7.9	40 x 40 x 24

9-4. Tearing Off Force

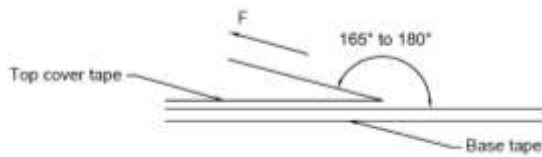

The force for tearing off cover tape is according to the follow table, in the arrow direction under the following conditions.

(Referenced ANSI/EIA-481-D-2008 of 4.11 standard)

Room Temp. (°C)	Room Humidity (%)	Room atm (hPa)	Tearing Speed (mm/min)
5~35	45~85	860~1060	300±10

Tape Size	8 mm	12 to 56 mm	72 mm or Wider
Tearing Off Force (grams)	10~100	10~130	10~150

Application Notice

1. Storage Conditions

To maintain the solderability of terminal electrodes:

- (a) Products meet IPC/JEDEC J-STD-020F standard-MSL, level 1.
- (b) Recommended products should be used within 12 months from the time of delivery.
- (c) The packaging material should be kept where no chlorine or sulfur exists in the air.

2. Transportation

- (a) Products should be handled with care to avoid damage or contamination from perspiration and skin oils.
- (b) Vacuum pick up is strongly recommended for individual components.
- (c) Bulk handling should ensure that abrasion and mechanical shock are minimized.

NOTE: Specifications subject to change without notice. Please check our website for latest information.